



**Fonology**  
sound architecture

**Chiudi gli occhi  
e ascolta l'architettura**

**Close your eyes  
and listen to architecture**

**Fermez les yeux  
et écoutez l'architecture**



# SPAZIO AL SUONO

FONOLOGY COLMA UN VUOTO.  
FONOLOGY È LA RISPOSTA SILENZIOSA  
A UNA RICHIESTA RUMOROSA.  
FONOLOGY SODDISFA IL BISOGNO DI  
BENESSERE ACUSTICO IN OGNI AMBIENTE.

## Scope for sound

FONOLOGY FILLS A GAP.  
FONOLOGY IS THE NOISELESS RESPONSE  
TO A LOUD REQUEST.  
FONOLOGY MEETS THE NEEDS OF ACOUSTIC  
COMFORT IN ANY ENVIRONMENT.

## Place au son

FONOLOGY COMBLE UN VIDE.  
FONOLOGY EST LA RÉPONSE SILENCIEUSE  
À UNE DEMANDE BRUYANTE. FONOLOGY  
SATISFAIT LE BESOIN DE BIEN-ÊTRE  
ACOUSTIQUE DANS TOUS LES ESPACES.

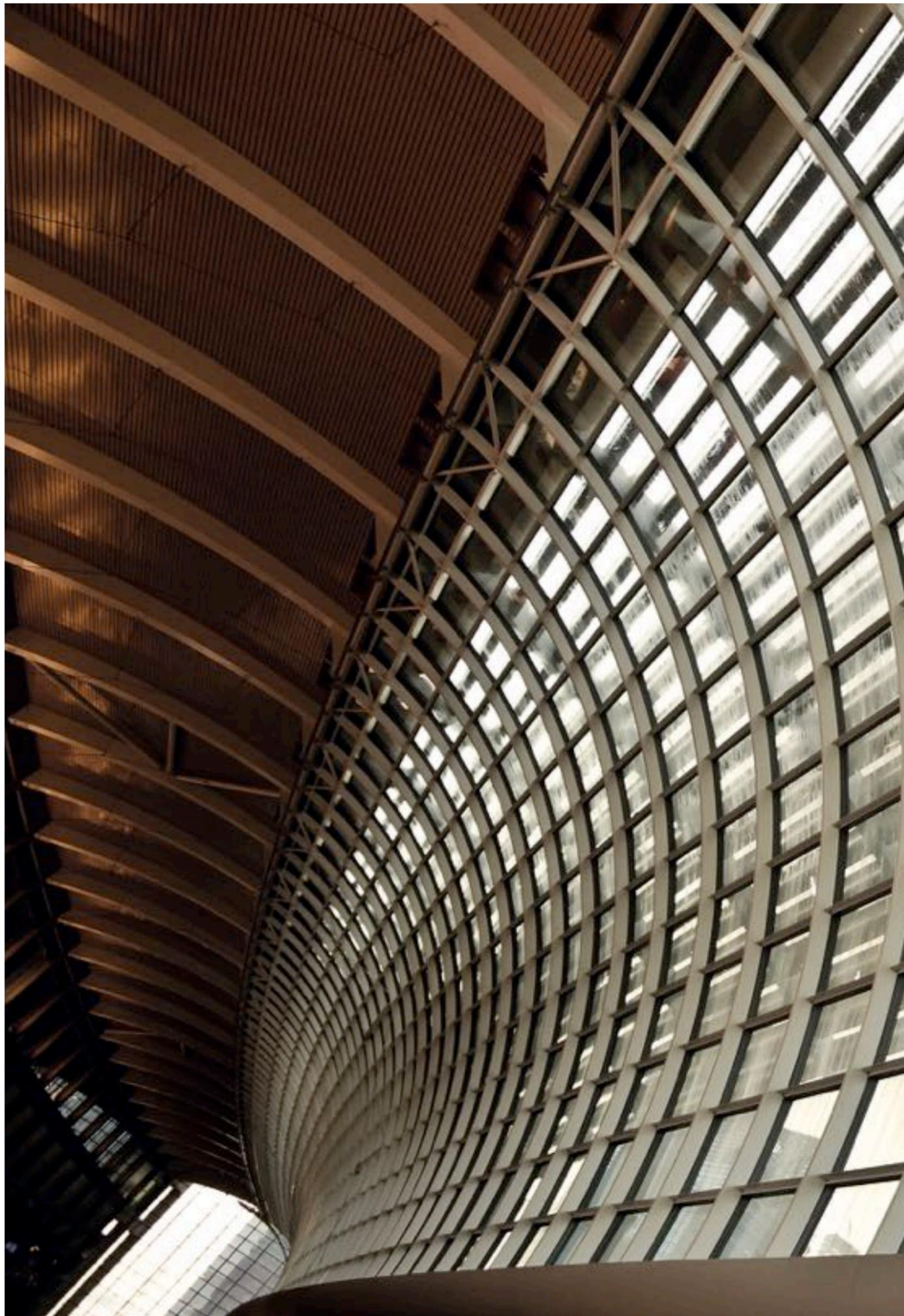

Acoustic performance

La performance acoustique

# LA PERFORMANCE ACUSTICA

IL MONDO È RUMOROSO.  
IL MONDO SI È ABITUATO AL RUMORE  
E LO CONSIDERA NORMALE.

Sono sempre più diffusi ambienti sonori che disturbano le diverse attività dell'individuo, attraverso i rumori di fondo, gli echi o la totale mancanza di riflesso sonoro. Fonology propone una stimolazione sensoriale che cambia la percezione del suono e il modo di concepire gli ambienti. L'educazione all'ascolto passa attraverso l'ergonomia acustica dello spazio, capace di donare una condizione psicofisica di benessere. L'assenza di disturbo, la buona ricezione e l'intelligibilità variano sia in relazione al volume di un ambiente sia in relazione alla distribuzione e alla tipologia dei materiali sulle diverse pareti e sui vari componenti di arredo.

> Il **comfort acustico** Fonology nasce dallo studio della spazialità nel suo complesso, da una visione globale che considera ogni dettaglio come un'opportunità di controllo dei toni, dei timbri, della riverberazione, dell'assorbimento e dell'isolamento del suono.

> La costante **ricerca** e la sperimentazione a livello mondiale dei migliori materiali fonoassorbenti sono alla base del progetto Fonology.

THE WORLD IS NOISY.  
THE WORLD HAS BECOME ACCUSTOMED  
TO NOISE AND CONSIDERS IT NORMAL.

Sound environments that disturb the various activities of individuals, such as background noise, echoes or the total absence of sound reflection, are becoming increasingly common. Fonology offers sensory stimulation that changes the perception of sound and the way we conceive environments. Learning to listen involves the acoustic ergonomics of space, which can provide a state of mental and physical wellbeing. The absence of any disturbance, good reception and intelligibility differ according to the dimensions of an environment and to the type of materials used for its various walls and furnishing elements.

> Fonology **acoustic comfort** arises from an assessment of overall spatiality, from a global vision that considers every detail an opportunity to inspect the tones, timbres, reverb, absorption and insulation of sound.

> The constant **research** and experimentation on a global scale of the best sound-absorbing materials are at the heart of project Fonology.

LE MONDE EST BRUYANT.  
LE MONDE S'EST HABITUÉ AU BRUIT  
ET LE CONSIDÈRE NORMAL.

Les environnements sonores dérangent les différentes activités de l'individu à cause de bruits de fond, d'échos ou de manque total de réflexe sonore sont de plus en plus fréquents. Fonology propose une stimulation sensorielle qui modifie la perception du son et la façon de concevoir les espaces. L'éducation à l'écoute passe par l'ergonomie acoustique de l'espace, en mesure de donner une condition psychophysique de bien-être. L'absence de gêne, la bonne réception et l'intelligibilité varient tant en fonction du volume d'un espace qu'en fonction de la répartition et du type de matériaux sur les parois et sur les différents éléments d'ameublement.

> Le **confort acoustique** Fonology naît de l'étude de la spatialité dans son ensemble, d'une vision globale qui considère chaque détail comme une opportunité de contrôler les tons, les timbres, la réverbération, l'absorption et l'isolation du son.

> La **recherche** et l'expérimentation constantes à l'échelle mondiale des meilleurs matériaux phonoabsorbants sont à la base du projet Fonology.



There is no limit to creativity if you are prepared to listen

Aucune limite à la créativité de celui qui a de l'oreille

PER CHI HA ORECCHIO, NESSUN LIMITE ALLA CREATIVITÀ

## IL VALORE AGGIUNTO SI SENTE

OGNI IDEA FONOLGY È CUSTOMIZZABILE.

> **su misura.** Sviluppiamo soluzioni su misura, grazie ad un ufficio tecnico che dialoga con il progettista per non porre limite alla creatività.

> **gusto italiano.** Linee, colori e profili innovativi, che aggiungono all'altissima funzionalità un forte impatto estetico dal gusto italiano.

> **competenza.** Accompagnamo il progettista nella scelta di prodotti integrabili tra loro e capaci di offrire la massima libertà creativa, grazie a finiture e decorazioni ricercate.

> **sinergia.** Forme, colori, grafiche e materiali vengono studiati in collaborazione con il committente, per arrivare alla piena soddisfazione delle sue esigenze e contemporaneamente alla certificazione finale sulle funzionalità.

> **tecnologia.** Per la determinazione puntuale delle caratteristiche acustiche di strutture, sistemi ed elementi, Fonology è supportata da partner di grande esperienza. Partner che si avvalgono di strumentazioni per la misurazione tecnologicamente avanzate e di laboratori di fisica tecnica, in stretta collaborazione con il mondo della ricerca.

You can hear the added value

ALL FONOLGY IDEAS CAN BE CUSTOMISED.

> **customised.** We develop customised solutions, thanks to an engineering department that liaises with the designer to place no limits on creativity.

> **italian style.** Innovative lines, colours and profiles bring the great aesthetic appeal of Italian style to highly functional elements.

> **competence.** We help designers select combinable products that offer maximum creative freedom, thanks to refined finishes and decorations.

> **synergy.** Shapes, colours, graphics and materials are designed in collaboration with customers in order fully to meet their needs and comply with final certification of functionality.

> **technology.** To determine the precise acoustic characteristics of structures, systems and elements, Fonology is supported by partner boasting lengthy experience. Partners who use high-tech measuring instruments and applied physics laboratories, in close collaboration with the world of research.



Une valeur ajoutée qui s'entend

TOUTES LES IDÉES FONOLGY PEUVENT ÊTRE PERSONNALISÉES.

> **sur mesure.** Nous créons des solutions sur mesure, grâce à un bureau technique en dialogue constant avec les concepteurs, pour permettre une créativité sans limites.

> **style italien.** Les lignes, les couleurs et les profils innovants ajoutent à la fonctionnalité optimale un fort impact esthétique de style italien.

> **compétence.** Nous accompagnons le concepteur de projets dans le choix de produits compatibles entre eux et permettant une liberté de création maximale, grâce à des finitions et des décorations recherchées.

> **synergie.** Formes, couleurs, graphiques et matériaux sont étudiés en collaboration avec le donneur d'ordres, afin d'atteindre un niveau de satisfaction totale de ses exigences tout en obtenant une certification finale des fonctionnalités.

> **technologie.** Afin de déterminer de manière ponctuelle les caractéristiques acoustiques des structures, des systèmes et des éléments, Fonology est soutenue par des partenaires de grande expérience. Ces partenaires utilisent des instruments de mesure à la pointe de la technologie et ont recours à des laboratoires de physique technique, en collaboration étroite avec le monde de la recherche.



For those  
who need  
our experience

Pour ceux qui  
ont besoin de  
notre expérience

PER CHI  
HA BISOGNO  
DELLA NOSTRA  
ESPERIENZA

# PROGETTAZIONE ACUSTICA

REALIZZAMO LE TUE IDEE E TI  
AFFIANCIAMO NELLA PROGETTAZIONE SU  
MISURA.

Fasi della progettazione acustica di ambienti  
in costruzione o ambienti esistenti da  
correggere:

> **verifica** teorica tramite modello acustico  
dei parametri di riverbero, intelligibilità,  
chiarezza e definizione per ambienti dedicati  
al parlato, con approfondimenti tecnici per  
sale musica, auditorium e ambienti di grandi  
dimensioni.

> Studio di nuove **soluzioni** e scelta dei  
materiali per la correzione in collaborazione  
con i clienti e gli architetti.

> Check **test** sul realizzato con possibile  
certificazione finale dell'ambiente.

## Acoustic design

WE MAKE YOUR IDEAS COME TO LIFE AND  
ASSIST YOU IN CUSTOMISED DESIGNS.

The stages of acoustic design for  
environments under construction or existing  
environments that need to be corrected are  
as follows:

> Theoretical **assessment**, using  
an acoustic model, of the parameters of  
reverberation, intelligibility, clarity and  
definition for environments designed  
for speaking, with technical analyses for  
music rooms, auditoriums and large-scale  
environments.

> Research into new **solutions** and  
the selection of materials for correction in  
collaboration with customers and architects.

> Check **tests** on the implemented project  
with final product certification.

## Conception acoustique

NOUS DONNONS FORME A VOS IDEES  
ET VOUS ACCOMPAGNONS DANS LEUR  
CONCEPTION SUR MESURE.

Phases de conception de projet acoustique  
pour sites en construction ou déjà existants  
à améliorer :

> **contrôle** théorique à l'aide de modèle  
acoustique des paramètres de réverbération,  
intelligibilité, clarté et définition pour  
les espaces dédiés à la parole, avec des  
approfondissements techniques pour les  
salles de musique, les auditoriums et les  
espaces de grandes dimensions.

> Étude de nouvelles **solutions** et choix  
des matériaux de correction en collaboration  
avec les clients et les architectes.

> Essai de **contrôle** sur le travail réalisé  
avec certification finale du produit possible.

# FONOLOGY. L'APPROCCIO MULTIMATERICO

**Fonology.**  
A multimaterial approach

**Fonology.**  
L'approche multimatérielle

Legno, lana, metallo, mdf, licheni stabilizzati, leghe preziose.  
Fonology è il punto di connessione tra il suono e la materia. Oltre all'utilizzo dei classici materiali assorbenti, Fonology impiega e converte i materiali riflettenti per antonomasia, trasformandoli ed elevandoli fino alla loro totale ottimizzazione acustica. Un approccio che consente la più vasta scelta materica, per la più ampia libertà di utilizzo e, soprattutto, per una nuova interpretazione della fono assorbenza.

Wood, wool, metal, MDF, stabilised lichens, precious metal alloys.  
Fonology is the connection point between sound and material. In addition to traditional sound absorbing materials, Fonology uses and converts reflective materials par excellence, transforming them and enhancing them to their full acoustic potential. An approach that allows for the broadest choice of materials, the widest freedom of use, and above all, a new interpretation of sound absorption.

Bois, laine, métal, MDF, lichens stabilisés, alliages précieux.  
Fonology est le point de rencontre entre le son et la matière. En plus des matériaux absorbants traditionnels, Fonology utilise et convertit les matériaux réfléchissants par excellence, en les transformant et en les améliorant jusqu'à leur complète optimisation acoustique. Une approche qui permet le choix le plus vaste de matériaux, pour la plus ample liberté d'utilisation et, surtout, pour une nouvelle interprétation de l'absorption acoustique.

## INDEX

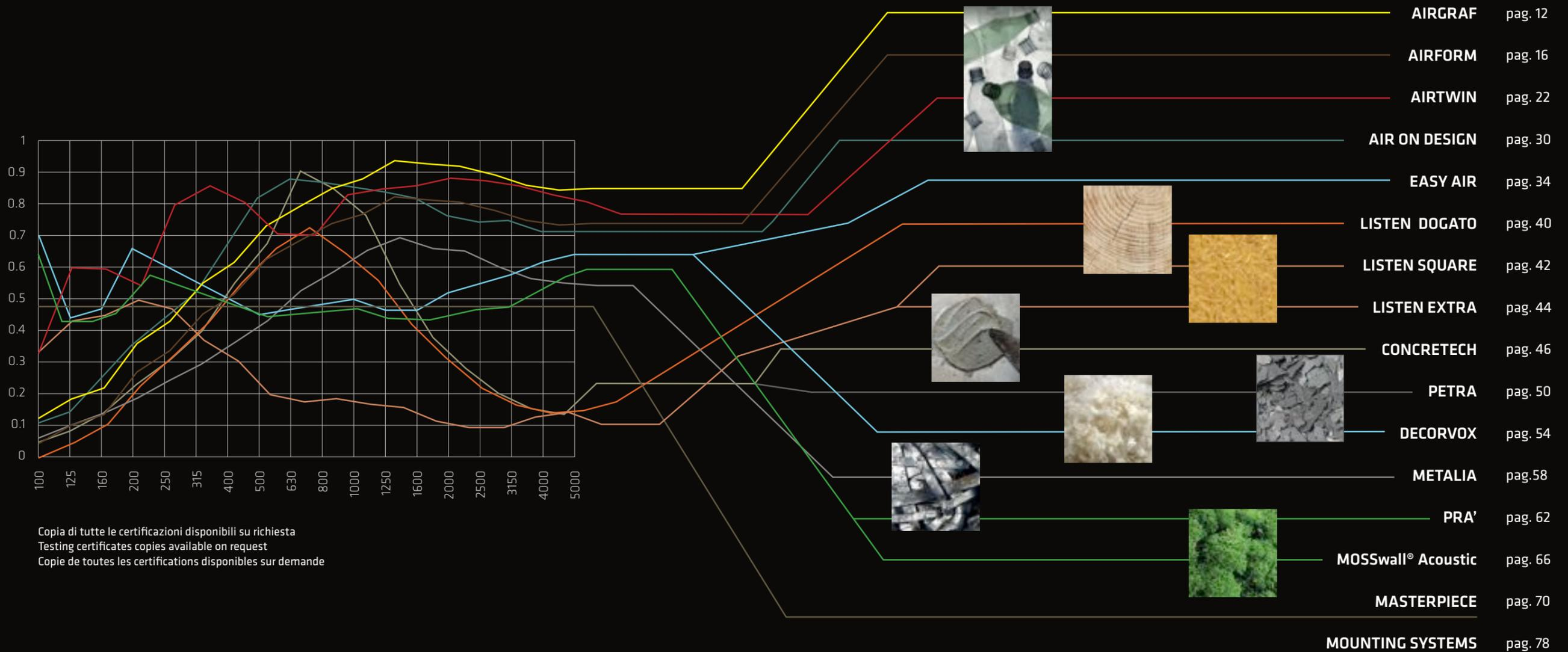

Copia di tutte le certificazioni disponibili su richiesta  
Testing certificates copies available on request  
Copie de toutes les certifications disponibles sur demande

# AIRGRAF

PANNELLO MODULARE FONOASSORBENTE  
E TERMOISOLANTE REALIZZATO  
IN FIBRA DI POLIESTERE

MODULAR POLYESTER FIBRE PANEL  
FOR THERMAL AND  
ACOUSTIC INSULATION

PANNEAU MODULAIRE INSONORISANT  
ET THERMO-ISOLANT RÉALISÉ  
EN FIBRE DE POLYESTER



Airgraf è composto da una percentuale di materiale (PET) riciclato.

Airgraf contains a percentage of recycled material (PET).

Airgraf se compose d'un pourcentage de matériau (PET) recyclé.

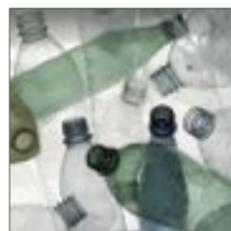

# > AIRGRAF

## LA CREATIVITÀ CHE SI SENTE

Airgraf migliora il comfort acustico e riduce il riverbero nel modo più pratico e creativo, con veri e propri graphic walls. È un pannello modulare fonoassorbente e termoisolante in fibra di poliestere al 100%. Alle alte prestazioni tecniche e a una lunga durata nel tempo unisce la possibilità di decorare pareti e soffitti in totale libertà. È possibile stampare i pannelli con grafiche personalizzate ad alta risoluzione.

## FEEL THE CREATIVITY

Airgraf improves acoustic comfort and reduces reverberation in the most practical and creative way, using real graphic walls. It is a modular 100% polyester fibre panel designed for thermal and acoustic insulation. In addition to ensuring high technical performance and long life, it can be used to decorate walls and ceilings according to the customer's own taste. The panels can be printed with high resolution customised graphics.

## LA CRÉATIVITÉ QUI SE SENT

Airgraf améliore le confort acoustique et réduit la réverbération de la façon la plus commode et la plus créative, à l'aide de véritables murs graphiques. Il s'agit d'un panneau modulaire insonorisant et thermo-isolant en fibre de polyester 100%. Aux excellentes performances techniques et à une durée prolongée dans le temps vient s'ajouter la possibilité de décorer les murs et les plafonds selon son propre goût esthétique. Il est possible d'imprimer les panneaux avec des graphismes personnalisés à haute résolution.

## Dimensioni / Size / Dimensions:

Moduli standard / Standard modules  
Modules standards:  
600 x 600 x 45 mm  
1200 x 600 x 45 mm

Su richiesta / On request / Sur demande:  
Max. 1200 x 2400 x 45 mm

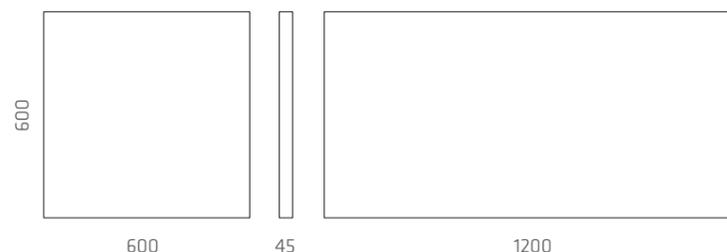

## DOVE E COME

Airgraf è eccellente per spazi pubblici dove l'attenzione alle norme di sicurezza impone l'utilizzo di prodotti certificati e con performance di alta qualità, compresi i luoghi con alta presenza di umidità, senza limitare l'inventiva dell'architetto e del designer nella realizzazione di ambienti accoglienti e ricercati.

## WHERE AND HOW

Airgraf is perfect for public venues where safety regulations require the use of certified products that ensure high-quality performance, including areas with high humidity levels, without limiting the inventiveness of architects and designers in the creation of welcoming and refined settings.

## OÙ ET COMMENT

Airgraf convient parfaitement aux espaces publics où l'attention pour les normes de sécurité impose l'utilisation de produits certifiés assurant d'excellentes performances, y compris les lieux avec un taux d'humidité élevé, sans limiter cependant la créativité de l'architecte et du concepteur lors de la réalisation d'espaces accueillants, raffinés.

## SCHEDA TECNICA

Pannello modulare in fibra di poliestere 100%, fonoassorbente e termoisolante, spessore 40 mm, ottenuto da riciclo PET e fibra termolegante. Cornice interna in legno, rivestimento su fronte e bordi laterali. I tessuti e la fibra sono ignifughi in classe 1.

## DATA SHEET

Modular 100% polyester fibre panel, sound-absorbing and thermo-insulating, 40 mm thick, obtained from recycled PET and thermo-bonding fibre. Inner wooden frame, covering on front and side edges. The fabrics and fibre are flame-retardant in class 1.

## FICHE TECHNIQUE

Panneau modulaire en fibre de polyester 100% phonoabsorbant et thermoisolant, épaisseur de 40 mm, obtenu par recyclage de PET et fibre thermoliant. Cadre intérieur en bois, revêtement sur l'avant et les côtés. Les tissus et les fibres sont ignifuges de classe 1.

## SISTEMA DI AGGANCIAMENTO

Cornice perimetrale in legno rivestita con il tessuto stampato, predisposta sul retro per attacco a parete. Possibilità di sospensione orizzontale a soffitto con morsetti regolabili.

## MOUNTING SYSTEM

Wood perimeter frame covered with printed fabric; the back is arranged for wall mounting. Possibility of horizontal ceiling suspension using adjustable clamps.

## SYSTÈME DE FIXATION

Cadre de pourtour en bois revêtu du tissu imprimé, préparé à l'arrière pour une fixation murale. Possibilité de suspension à l'horizontale au plafond avec des fixations réglables.

## CAMPIONE SOTTOPOSTO A PROVA

Pannello in Poliestere.  
Installazione in aderenza.  
Norma di riferimento:  
UNI EN ISO 354: 2003  
UNI EN ISO 11654: 1998.

## SAMPLE TESTED

Polyester panel.  
Flush installation.  
Reference standard:  
UNI EN ISO 354: 2003  
UNI EN ISO 11654: 1998.

## ÉCHANTILLON SOUMIS À ESSAIS

Panneau en polyester.  
Installation adhérente.  
Norme de référence:  
UNI EN ISO 354:2003  
UNI EN ISO 11654:1998.

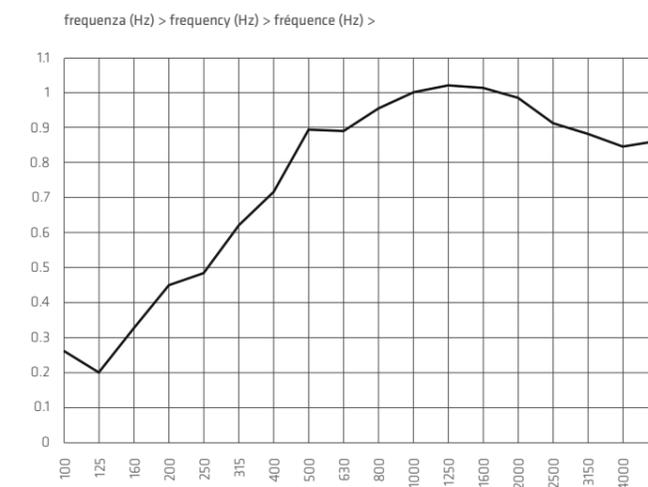

## SCHEDA TECNICA

- Coefficiente di assorbimento acustico: (UNI EN ISO 354, UNI EN ISO 11654)  $\alpha_w=0.75$  (installazione in aderenza),
- Densità 50 Kg/m<sup>3</sup>
- Conducibilità termica:  $\lambda=0.036$  W/mK
- Fattore di resistenza alla diffusione del vapore  $\mu=3.11$  (EN 12086)
- Classificazione fumi F1 (NF F 16-101)
- Tessuti certificati (confrontare cartella colori Ares Line)

## DATA SHEET

- Sound absorption coefficient: (UNI EN ISO 354, UNI EN ISO 11654)  $\alpha_w=0.75$  (flush installation)
- Density 50 Kg/m<sup>3</sup>
- Conductivity:  $\lambda=0.036$  W/mk
- Water vapour resistance factor  $\mu=3.11$  (EN 12086)
- Fire classification F1 (NF F 16-101)
- Certified fabrics (compare Ares Line colour chart)

## FICHE TECHNIQUE

- Coefficient d'absorption acoustique : (UNI EN ISO 354, UNI EN ISO 11654)  $\alpha_w=0,75$  (montage adhérent),
- Densité 50 kg/m<sup>3</sup>
- Conductivité:  $\lambda=0,036$  W/mK
- Facteur de résistance à la diffusion de la vapeur  $\mu=3.11$  (EN 12086)
- Classification Fumée F1 (NF F 16-101)
- Tissus certifiés (consulter la palette de couleurs Ares Line)

## CARTELLA COLORI / COLOUR CHART / PALETTE DE COULEURS

Il rivestimento può essere, a scelta, in tessuto Trevira secondo cartella colori Ares Line o stampato con stampa digitale su tessuto per quadri monofacciale da 250 gr.

The covering can be, at the customer's choice, in Trevira fabric according to the Ares Line colour chart or digitally printed on fabric for 250 gram single-sided squares.

Le revêtement utilisé peut être, au choix, le tissu Trevira (présenté dans la palette de couleurs Ares Line) ou un tissu imprimé avec un motif numérique pour les cadres monoface de 250 g.

## COLORI DISPONIBILI / COLOURS AVAILABLE / COULEURS DISPONIBLES



## ALTRI COLORI / OTHER COLOURS / AUTRES COULEURS

Possibilità di variazione dei test acustici. Possibility of variation of the acoustic tests. Possibilité de variation des essais acoustiques.



# AIRFORM

design: Paolo Pampanoni

PANNELLO MODULARE FONDOASSORBENTE  
E TERMOISOLANTE REALIZZATO  
IN FIBRA DI POLIESTERE

MODULAR POLYESTER FIBRE PANEL  
FOR THERMAL AND  
ACOUSTIC INSULATION

PANNEAU MODULAIRE INSONORISANT  
ET THERMO-ISOLANT RÉALISÉ  
EN FIBRE DE POLYESTER



Airform è composto da una percentuale di materiale (PET) riciclato.

Airform contains a percentage of recycled material (PET).

Airform se compose d'un pourcentage de matériau (PET) recyclé.



# > AIRFORM

design: Paolo Pampanoni

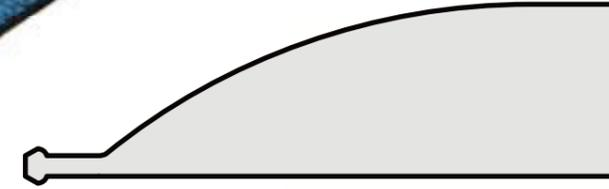

Sezione / Cross section / Coupe

## LA FONOASSORBENZA A TUTTO TONDO

Airform è un pannello modulare fonoassorbente e termoisolante in fibra di poliestere al 100%. Il particolare processo di termoformatura accoppia alla perfezione il tessuto Trevira CS alla fibra in poliestere, caratterizzando Airform con particolari bordi bombati esteticamente piacevoli, che liberano dalla necessità di cornici di supporto.

## ALL-ROUND SOUNDPROOFING

Airform is a modular 100% polyester fibre panel designed for thermal and acoustic insulation. A special thermoforming process perfectly combines Trevira CS fabric and polyester fibres to create Airform's distinctive and aesthetically appealing rounded sides, without requiring any support frames.

## L'INSONORISATION À 360 DEGRÉS

Airform est un panneau modulaire insonorisant et thermo-isolant en fibre de polyester 100%. Le processus particulier de thermoformage accouple à la perfection le tissu Trevira CS à la fibre polyester et caractérise ainsi Airform grâce à des bords bombés esthétiquement agréables, qui suppriment le besoin de cadres de support.

## Dimensioni / Size / Dimensions :

Quadrato / Square / Carré  
600 x 600 x 30 mm

Rettangolare / Rectangular / Rectangulaire  
1200 x 600 x 30 mm

Altre forme disponibili su progetto  
Other customised project shapes available  
Possibilité de variation des essais acoustiques

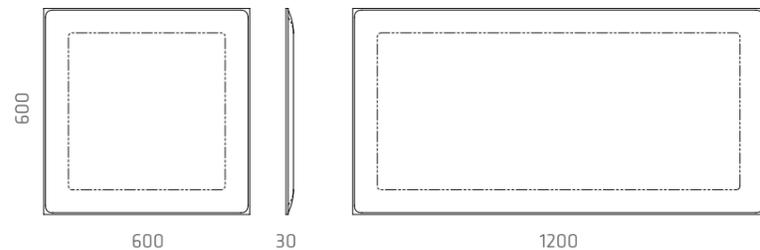

## DOVE E COME

Airform può essere installato con un solo lato a vista, lungo le pareti, come controsoffitto o come plafone, per correggere il riverbero senza limitare la creatività. I diversi sistemi di installazione accentuano la flessibilità del prodotto e ne permettono l'utilizzo in ogni tipo di ambiente.

## WHERE AND HOW

Airform can be installed with only one visible side, along the walls, as a false ceiling or plafond, to correct reverberation without stifling creativity. The different installation systems available emphasise the product's flexibility, making it suitable for all kinds of environments.

## OÙ ET COMMENT

Airform peut être installé avec un seul côté apparent, le long des murs, comme faux plafond ou comme plafone, pour corriger la réverbération sans limiter la créativité. Les différents systèmes d'installation accentuent la flexibilité du produit et permettent de l'utiliser dans les endroits les plus divers.

## SCHEMA TECNICA

Pannello modulare in fibra di poliestere 100% fonoassorbente e termoisolante, Spessore 30 mm, sagomato " BOMBATO 1 lato " per termofusione fino a 5 mm di spessore sui quattro lati. Retro pannello con tessuto velcro.

## DATA SHEET

100% polyester fibre modular panel for heat and sound insulation. 30 mm thick, hot melt "ROUNDED on 1 side" to a thickness of 5 mm on all four sides. Back of panel with Velcro fabric.

## FICHE TECHNIQUE

Pannello modulare in fibra di poliestere 100% insonorisant et thermo-isolant. Épaisseur 30 mm, façonné « BOMBÉ 1 côté » par thermoformage jusqu'à 5 mm d'épaisseur sur les quatre côtés. Pannello arrière en tissu velcro.

## SISTEMA DI AGGANCIAMENTO

AIRFIX® a parete o soffitto.  
T24 a soffitto.  
Sistema a bandelle per composizioni affiancate.

## MOUNTING SYSTEM

Wall or ceiling AIRFIX®  
T24 ceiling grid.  
System with strips for side-by-side compositions.

## SYSTÈME DE FIXATION

AIRFIX® au mur ou au plafond.  
T24 au plafond.  
Systèmes à bandes pour assemblage de compositions.

## CAMPIONE SOTTOPOSTO A PROVA

Pannello in fibra di poliestere + tessuto Trevira.  
Installazione con intercapedine mm. 150.  
Norma di riferimento:  
UNI EN ISO 354: 2003  
UNI EN ISO 11654: 1998

## SAMPLE TESTED

Polyester fibre panel + Trevira fabric.  
Installation with 150 mm air space.  
Reference standard:  
UNI EN ISO 354: 2003  
UNI EN ISO 11654: 1998

## ÉCHANTILLON SOUMIS À ESSAIS

Panneau fibre polyester + tissu Trevira.  
Installation avec double paroi 150 mm.  
Norme de référence:  
UNI EN ISO 354:2003  
UNI EN ISO 11654:1998

frequenza (Hz) > frequency (Hz) > fréquence (Hz) >

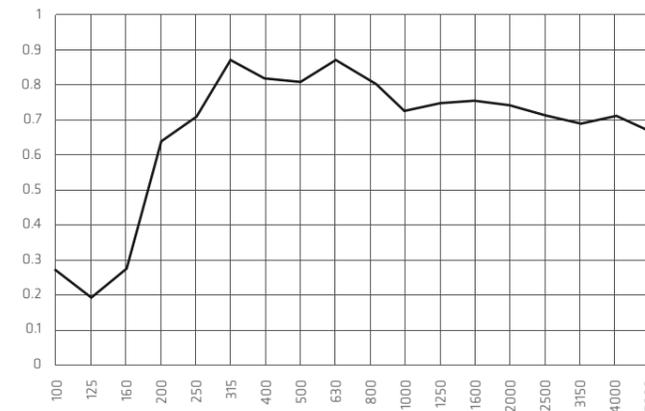

coefficiente di assorbimento acustico (α) >  
sound absorption coefficient (α) >  
coefficient d'absorption acoustique (α) >

## Prodotto in CLASSE B

- Coefficiente di assorbimento acustico ponderato: (UNI EN ISO 354, UNI EN ISO 11654)  
 $\alpha_w = 0,80$  (montaggio distanziato 15 cm da parete)
- Densità 40 Kg/m<sup>3</sup>
- Conducibilità termica:  $\lambda = 0,037$  W/mk
- Reazione al fuoco: B s1 d0 (EN 13501-1; EN ISO 11925-2; EN 13823)
- Fattore di resistenza alla diffusione del vapore  $\mu = 3,2$  (EN 12086)
- Certificazione VOC (UNI EN ISO 16000-9:2006, ISO 16000-6:2011)
- Tessuti certificati (confrontare cartella colori Ares Line)

## Product in class B

- Sound absorption coefficient ponderato: (UNI EN ISO 354, UNI EN ISO 11654)  
 $\alpha_w = 0,80$  (installation at a distance of 15 cm from ceiling/wall)
- Density 40 Kg/m<sup>3</sup>
- Conductivity:  $\lambda = 0,037$  W/mk
- Reaction to fire: B s1 d0 (EN 13501-1; EN ISO 11925-2; EN 13823)
- Water vapour resistance factor  $\mu = 3,2$  (EN 12086)
- VOC certification (UNI EN ISO 16000-9:2006, ISO 16000-6:2011)
- Certified fabrics (compare Ares Line colour chart)

## Produit in class B

- Coefficient d'absorption acoustique ponderato: (UNI EN ISO 354, UNI EN ISO 11654)  
 $\alpha_w = 0,80$  (montage à 15 cm de distance du plafond/mur)
- Densité 40 kg/m<sup>3</sup>
- Conductivité:  $\lambda = 0,037$  W/mk
- Réaction au feu: B s1 d0 (EN 13501-1; EN ISO 11925-2; EN 13823)
- Facteur de résistance à la diffusion de la vapeur  $\mu = 3,2$  (EN 12086)
- Certification VOC (UNI EN ISO 16000-9:2006, ISO 16000-6:2011)
- Tissus certifiés (consulter la palette de couleurs Ares Line)

## CARTELLA COLORI / COLOUR CHART / PALETTE DE COULEURS

Tessuti Trevira secondo cartella colori Ares Line.  
Trevira fabrics according to Ares Line colour chart.  
Tissus Trevira (consulter la palette de couleurs Ares Line).

## COLORI DISPONIBILI / COLOURS AVAILABLE / COULEURS DISPONIBLES



## COLORI OPZIONALI TESTATI (min. 20 pezzi) / OPTIONAL TESTED COLOURS (min. 20 pieces) / COULEURS EN OPTION TESTÉES (au moins 20 échantillons)



## ALTRI COLORI / OTHER COLOURS / AUTRES COULEURS

Possibilità di variazione dei test acustici.  
Possibility of variation of the acoustic tests.  
Possibilité de variation des essais acoustiques.

# > AIRFORM design: Paolo Pampanoni

## APPLICAZIONE A PARETE / WALL APPLICATION / APPLICATION MURALE

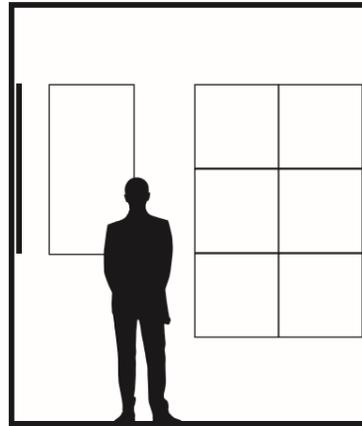

Pannelli acustici studiati per composizioni complanari di grande valore tecnico ed estetico. Ancoraggi a parete con sistema AIRFIX® , per garantire una corretta installazione su ogni superficie.

Acoustic panels designed for geometric compositions of great technical and aesthetic value. Wall anchors with AIRFIX® system, to ensure correct installation on any type of surface.

Panneaux acoustiques conçus pour des compositions coplanaires de grande valeur technique et esthétique. Fixations au mur à l'aide du système AIRFIX® pour garantir une installation correcte sur toutes les surfaces.

## APPLICAZIONE A PARETE / WALL APPLICATION / APPLICATION MURALE

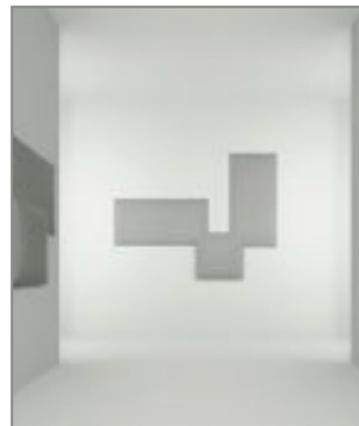
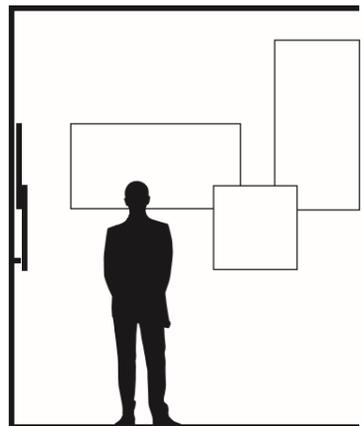

Composizioni geometriche per sovrapporre forme e colori. Giochi di piani e livelli, per allestimenti creativi e stimolanti. Distanziali a spessore differenziato con sistema AIRFIX® .

Geometric compositions to combine shapes and colours. Different planes and levels overlap for creative and eye-catching installations. Spacers with different thicknesses, with AIRFIX® system.

Compositions géométriques pour superposer formes et couleurs. Jeux de surfaces et de niveaux pour obtenir des aménagements créatifs et stimulants. Entretoises à épaisseur différenciée avec système AIRFIX®.

## APPLICAZIONE A PARETE / WALL APPLICATION / APPLICATION MURALE

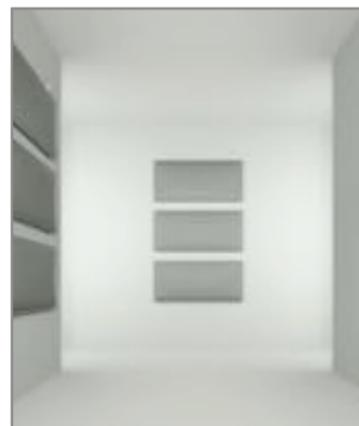
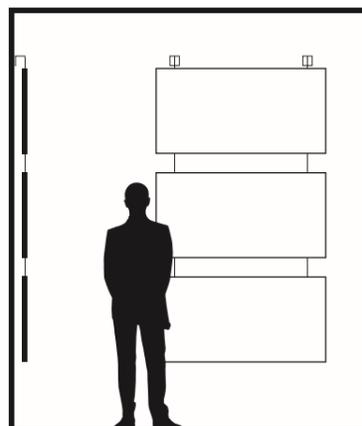

Elementi sospesi che sfiorano le pareti consentendo variazioni di posizione e formato, grazie al sistema AIRFIX® integrato con cavi d'acciaio, staffe e morsetti.

Suspended elements border the walls allowing for different positions and sizes, thanks to the AIRFIX® integrated system with steel cables, brackets and clamps.

Éléments suspendus qui effleurent les murs et permettent des variations de position et de format, grâce au système AIRFIX® intégré comprenant câbles en acier, étriers et brides.

## APPLICAZIONE A SOFFITTO / CEILING APPLICATION / APPLICATION AU PLAFOND

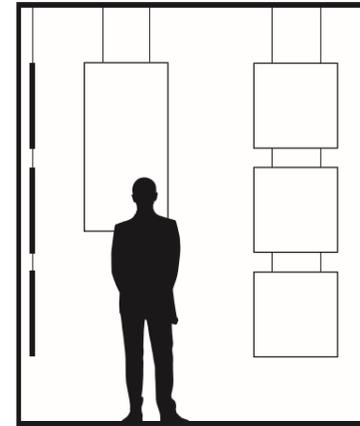

Sospensioni da soffitto per assorbire il suono creando setti variabili per forma e dimensione. Soluzioni AIRFIX® per ancoraggi flessibili, liberi, a soffitto o su binari in alluminio, a vista o incasso.

Suspend panels absorb the sound while creating partitions of different shapes and sizes. AIRFIX® solutions for flexible and free installations, attached to the ceiling or to aluminium rails, flush or surface-mounted.

Suspensions fixées au plafond pour absorber le son en créant ainsi des cloisons variables de par leur forme et leur dimension. Solutions AIRFIX® pour des fixations flexibles, libres, au plafond ou sur des rails en aluminium, apparents ou encastrés.

## APPLICAZIONE A CONTROSOFFITTO / FALSE CEILING APPLICATIONS / APPLICATION AU FAUX PLAFOND

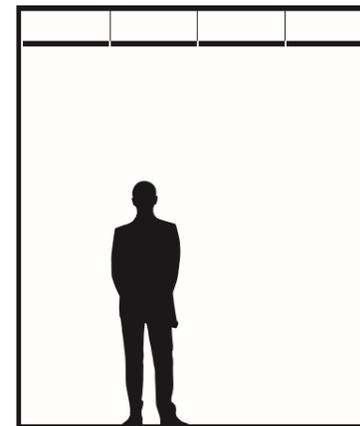

Controsoffitti acustici a struttura modulare metallica "T24", formato 600x600/1200 mm.

Acoustic false ceilings with modular metal structure "T24", 600x600/1200 mm.

Faux plafonds acoustiques à structure modulaire métallique « T24 », format 600 x 600/1200 mm.

## APPLICAZIONE A PARETE CON RETROILLUMINAZIONE / WALL APPLICATION WITH BACKLIGHTING / APPLICATION MURALE AVEC RÉTROÉCLAIRAGE

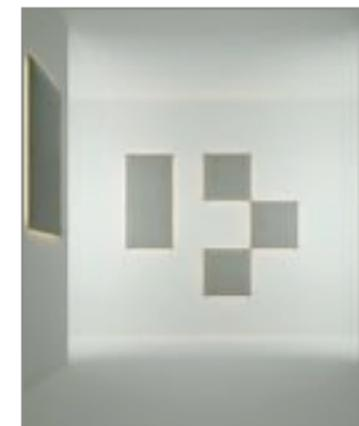
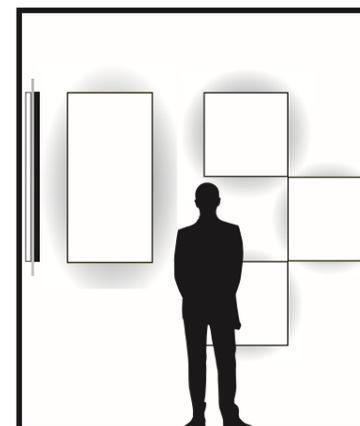

Soluzioni esclusive di retroilluminazione a led per ottenere piacevoli effetti scenografici a parete. Corpi illuminanti studiati per garantire la perfetta installazione dei pannelli acustici di vario formato.

Unique LED backlighting solutions to create spectacular effects on the wall. Luminaires designed to ensure perfect installation of acoustic panels of various sizes.

Solutions exclusives de rétroéclairage à LED pour obtenir d'agréables effets scénographiques muraux. Luminaires conçus pour garantir la parfaite installation des panneaux acoustiques de différent format.



# AIRTWIN

design: Paolo Pampanoni

PANNELLO MODULARE FONDOASSORBENTE  
E TERMOISOLANTE REALIZZATO  
IN FIBRA DI POLIESTERE

MODULAR POLYESTER FIBRE PANEL  
FOR THERMAL AND  
ACOUSTIC INSULATION

PANNEAU MODULAIRE INSONORISANT  
ET THERMO-ISOLANT RÉALISÉ  
EN FIBRE DE POLYESTER

thanks to DELLA VALENTINA OFFICE Spa



Airform è composto da una percentuale di materiale (PET) riciclato.

Airform contains a percentage of recycled material (PET).

Airform se compose d'un pourcentage de matériau (PET) recyclé.

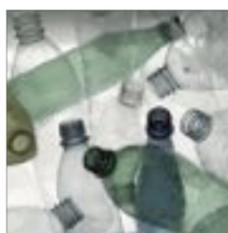

# > AIRTWIN

design: Paolo Pampanoni

Sezione / Cross section / Coupe

## IL DOPPIO LATO DEL BENESSERE

Questo pannello modulare fonoassorbente e termoisolante raddoppia i particolari bordi bombati di Airform, proponendoli su ambedue le facce, per una esposizione totale sui due lati. Soluzione estetica e funzionale, ideale per separare ambienti tramite moduli sospesi, con entrambe le superfici a vista disponibili anche con colori diversi.

## DOUBLE SIDED WELLNESS

This modular and acoustical panel features double molded edges like Airform panels. The acoustical properties are functional on both sides, for double sided acoustical wellness. This solution is both aesthetically pleasing and functional. Ideal for privacy and acoustical purposes in open environments, available with both sides upholstered in a variety of different colour finishes.

## DOUBLE FACE BIEN-ÊTRE

Ce panneau modulaire phono-absorbant et thermo-isolant dédouble les particularités de l' Airform en proposant des faces bombées des deux côtés, pour une présentation recto-verso. Solution esthétique et fonctionnelle idéale pour séparer les environnements grâce à des modules suspendus, avec deux faces visibles disponibles en différentes couleurs.

## Dimensioni / Size / Dimensions :

Quadrato / Square / Carré  
600 x 600 x 33 mm

Rettangolare / Rectangular / Rectangulaire  
1200 x 600 x 33 mm

Altre forme disponibili su progetto  
Other customised project shapes available  
Autres formes disponibles selon projet

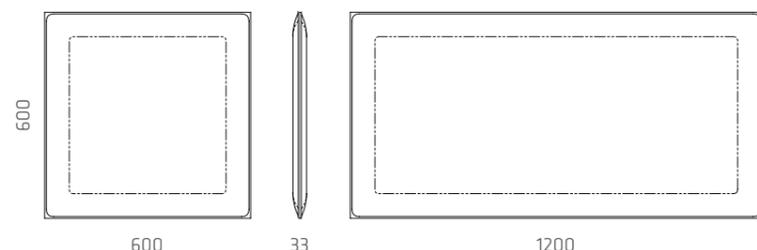

## DOVE E COME

La più ampia flessibilità di utilizzo per un prodotto perfetto per essere accostato a vetrate divisorie o per delimitare gli spazi. Per unire in un unico oggetto la praticità della fono assorbente alla bellezza di un dettaglio capace di trasmettere un senso di calore e accoglienza.

## WHERE AND HOW

This product ensures the greatest flexibility of use. It can be perfectly matched with glass partitions or used to define spaces, to merge into a single object the convenience of soundproofing and the beauty of a furnishing item that conveys warmth and comfort.

## OÙ ET COMMENT

Le maximum de flexibilité lors de l'utilisation d'un produit parfait pour être combiné à des cloisons vitrées de division ou pour délimiter les espaces. Pour allier en un seul objet la commodité de l'insonorisation et la beauté d'un détail capable de transmettre une sensation de chaleur et d'accueil.

## SCHEMA TECNICA

Pannello modulare in fibra di poliestere 100% fonoassorbente e termoisolante, spessore 33 mm, sagomato " BOMBATO 2 lati " per termofusione fino a 5 mm di spessore sui quattro lati.

## DATA SHEET

100% polyester fibre modular panel for thermal and acoustic insulation + Trevira fabric, 33mm thick, hot melt "ROUNDED on 2 sides" to a thickness of 5 mm on all four sides.

## FICHE TECHNIQUE

Panneau modulaire en fibre de polyester 100% insonorisant et thermo-isolant + tissu Trevira, épaisseur 33 mm, façonné « BOMBÉ 2 côtés » par thermoformage jusqu'à 5 mm. d'épaisseur sur les quatre côtés.

## SISTEMA DI AGGANCIAMENTO

AIRFIX® a parete o soffitto. T24 a soffitto. Sistema a bandelle per composizioni affiancate.

## MOUNTING SYSTEM

Wall or ceiling AIRFIX® T24 ceiling grid. System with strips for side-by-side compositions.

## SYSTÈME DE FIXATION

AIRFIX® au mur ou au plafond. T24 au plafond. Systèmes à bandes pour assemblage de compositions.

## CAMPIONE SOTTOPOSTO A PROVA

Pannello in fibra di poliestere + tessuto Trevira. Installazione con intercapedine mm. 150. Norma di riferimento: UNI EN ISO 354: 2003 UNI EN ISO 11654: 1998

## SAMPLE TESTED

Polyester fibre panel + Trevira fabric. Installation with 150 mm air space. Reference standard: UNI EN ISO 354: 2003 UNI EN ISO 11654: 1998

## ÉCHANTILLON SOUMIS À ESSAIS

Panneau fibre polyester + tissu Trevira. Installation avec double paroi 150 mm. Norme de référence : UNI EN ISO 354:2003 UNI EN ISO 11654:1998

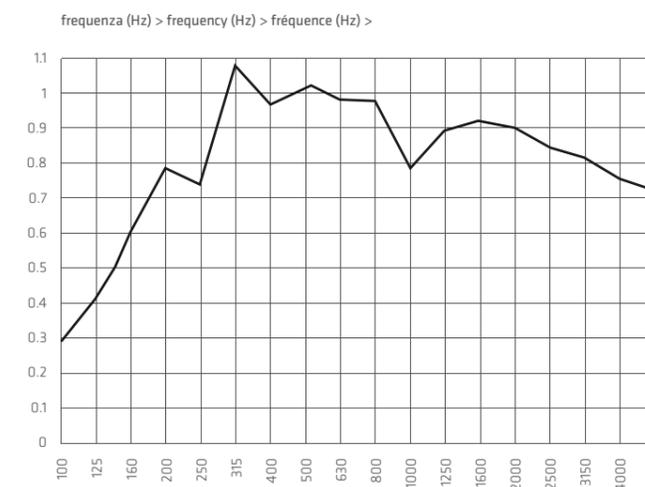

coefficiente di assorbimento acustico (α<sub>w</sub>) >  
sound absorption coefficient (α<sub>w</sub>) >  
coefficient d'absorption acoustique (α<sub>w</sub>) >

## Prodotto in CLASSE A

- Coefficiente di assorbimento acustico: α<sub>w</sub>=0.90 Classe A (installazione distanziata 15cm da soffitto/parete)
- Densità 50 Kg/m<sup>3</sup>
- Conduttività: λ=0.0032 W/mk (UNI EN 12664-02)
- Resistenza termica: 1.173 mqKW/1
- Reazione al fuoco: B s1 d0 (EN 13501-1; EN ISO 11925-2; EN 13823)
- Fattore di resistenza alla diffusione del vapore μ=3.1
- Classificazione fumi F1 (NF F 16-101)
- Certificazione VOC (UNI EN ISO 16000-9:2006, ISO 16000-6:2011)
- Tessuti certificati (confrontare cartella colori AresLine)

## Product in class A

- Sound absorption coefficient: α<sub>w</sub>=0.90 (installation at a distance of 15cm of ceiling/wall)
- Density 50 Kg/m<sup>3</sup>
- Conductivity: λ=0.0032 W/mk (UNI EN 12664-02)
- Thermal Resistance: 1.173 mqKW/1
- Reaction to fire: B s1 d0 (EN 13501-1; EN ISO 11925-2; EN 13823)
- Water vapour resistance factor μ=3.1
- Fire classification F1 (NF F 16-101)
- VOC certification (UNI EN ISO 16000-9:2006, ISO 16000-6:2011)
- Certified fabrics (compare Ares Line colour chart)

## Produit in class A

- Coefficient d'absorption acoustique: α<sub>w</sub>=0,90 (fixation avec une distance de 15cm au plafond/mur),
- Densité 50 kg/m<sup>3</sup>
- Conductivité: λ=0.0032 W/mk (UNI EN 12664-02)
- Résistance thermique: 1173 m<sup>2</sup>KW/1
- Réaction au feu : B s1 d0 (EN 13501-1; EN ISO 11925-2; EN 13823)
- Facteur de résistance à la diffusion de la vapeur μ=3,1
- Classification Fumée F1 (NF F 16-101)
- Certification VOC (UNI EN ISO 16000-9:2006, ISO 16000-6:2011)
- Tissus certifiés (consulter la palette de couleurs Ares Line)

## CARTELLA COLORI / COLOUR CHART / PALETTE DE COULEURS

Tessuto Trevira secondo cartella colori Ares Line. Trevira fabric according to Ares Line colour chart. Tissu Trevira (consulter la palette de couleurs Ares Line).

## COLORI DISPONIBILI / COLOURS AVAILABLE / COULEURS DISPONIBLES



## COLORI OPZIONALI TESTATI (min. 20 pezzi) / OPTIONAL TESTED COLOURS (min. 20 pieces) / COULEURS EN OPTION TESTÉES (au moins 20 échantillons)



## ALTRI COLORI / OTHER COLOURS / AUTRES COULEURS

Possibilità di variazione dei test acustici. Possibility of variation of the acoustic tests. Possibilité de variation des essais acoustiques.

# > AIRTWIN

design: Paolo Pampanoni

## APPLICAZIONE AUTOPORTANTE / STAND ALONE APPLICATION / APPLICATION AUTOPORTANTE

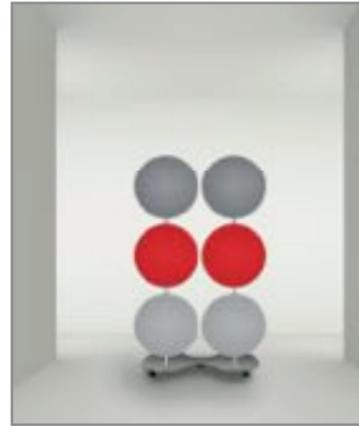
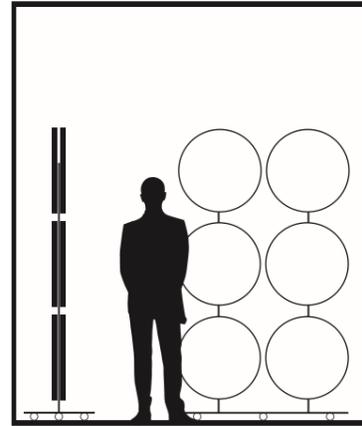

Applicazione autoportante di pannelli acustici bifacciali tondi. Ogni supporto con ruote può ospitare massimo 12 pannelli.

Stand alone application of round double-sided acoustic panels. Each support with wheels can accommodate up to a maximum of 12 panels.

Application autoportante de panneaux acoustiques ronds double face. Chaque support sur roues peut accueillir jusqu'à 12 panneaux.

## APPLICAZIONE AUTOPORTANTE / STAND ALONE APPLICATION / APPLICATION AUTOPORTANTE

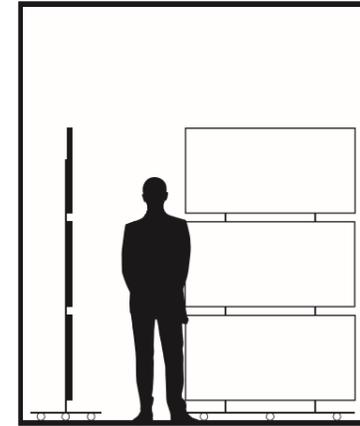

Applicazione autoportante di pannelli acustici bifacciali rettangolari. Ogni supporto con ruote può ospitare fino a 6 pannelli.

Stand alone application of rectangular double-sided acoustic panels. Each support with wheels can accommodate up to 6 panels.

Application autoportante de panneaux acoustiques rectangulaires double face. Chaque support sur roues peut accueillir jusqu'à 6 panneaux.

## APPLICAZIONE A VETRO / GLASS APPLICATION / APPLICATION SUR VITRE

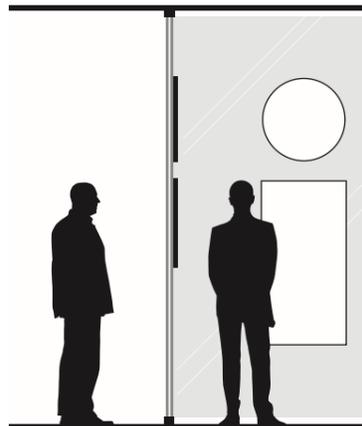

Pannelli acustici bifacciali ideali per l'installazione su pareti divisorie in vetro, mono e doppia lastra. Gli ancoraggi AIRFIX®, meccanici o magnetici, consentono flessibilità e facilità di montaggio.

Two-sided acoustic panels ideal for installation on single and double-panel glass partitions. AIRFIX® mechanical or magnetic anchors ensure high flexibility and easy installation.

Panneaux acoustiques double face parfaits pour être installés sur des cloisons vitrées de division, simple et double vitrage. Les fixations AIRFIX® ®, mécaniques ou magnétiques, assurent flexibilité et facilité de montage.

## APPLICAZIONE A SOFFITTO / CEILING APPLICATION / APPLICATION AU PLAFOND

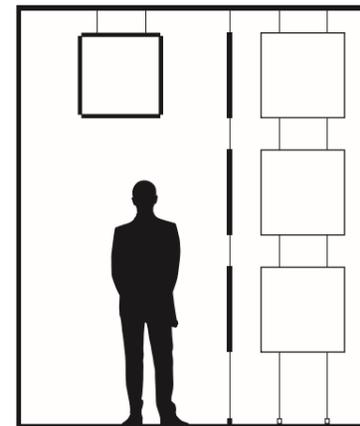

Sospensioni a soffitto a libera installazione, per assorbire il suono creando composizioni variabili per forma e dimensione. Agganci superiori AIRFIX® e zavorre di stabilizzazione a pavimento.

Free-standing suspended panels hanging from the ceiling, to absorb the sound while creating compositions of different shapes and sizes. AIRFIX® upper clips and stabilising counterweights on the floor.

Suspensions fixées librement au plafond pour absorber le son en créant ainsi des compositions variables de par leur forme et leur dimension. Fixations supérieures AIRFIX® et poids de stabilisation au sol.

## APPLICAZIONE A PARETE / WALL APPLICATION / APPLICATION MURALE

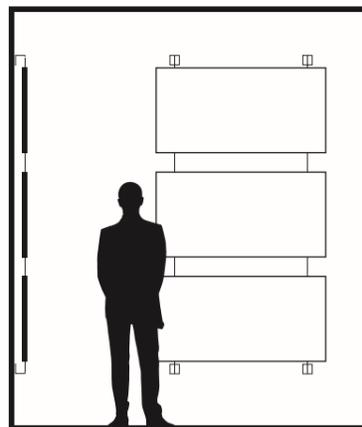

Elementi sospesi a parete che consentono variazioni di posizione e formato grazie al sistema di ancoraggio AIRFIX® integrato con cavetti in acciaio, staffe superiori, inferiori e morsetti.

Suspended elements hang on the walls allowing for different positions and sizes, thanks to the AIRFIX® integrated system with steel cables, upper and lower brackets, clamps.

Éléments suspendus au mur qui permettent des variations de position et de format, grâce au système AIRFIX® intégré comprenant câbles en acier, étriers supérieurs et inférieurs et brides.

## APPLICAZIONE A CONTROSOFFITTO / FALSE CEILING APPLICATION / APPLICATION AU FAUX PLAFOND

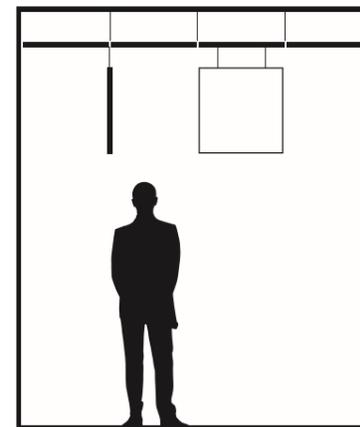

Applicazione di pannelli acustici mediante agganci supplementari che si fissano direttamente alla struttura metallica T24 del controsoffitto esistente.

Application of acoustic panels with additional clips attached to the T24 metal structure of the existing ceiling.

Faux plafonds acoustiques avec fixations supplémentaires qui se fixent directement sur les structures existantes à structure modulaire métallique « T24 ».

# > AIRTWIN

design: Paolo Pampanoni

## APPLICAZIONE A SOFFITTO POLIGONALE / POLYGONAL CEILING APPLICATION / APPLICATION POLYGONALE AU PLAFOND

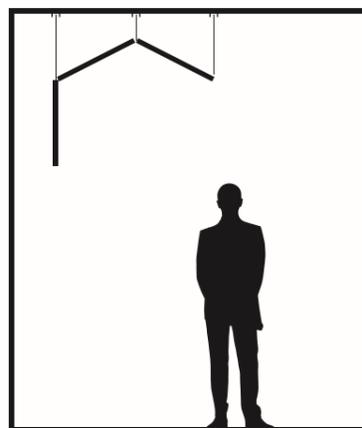

Composizioni di pannelli bifacciali ad andamento poligonale ottenuto con esclusivi connettori a cerniera. Ancoraggi a soffitto AIRFIX®, per installazione libera o su binari in alluminio estruso.

Compositions of double sided panels that create a polygonal pattern, obtained with special hinge connectors. AIRFIX® ceiling anchors for installation on extruded aluminium rails or free installation.

Compositions de panneaux double face à configuration polygonale obtenue grâce à d'exclusifs connecteurs à charnière. Fixations au plafond AIRFIX®, pour une installation libre ou sur des rails en aluminium extrudé.

## APPLICAZIONE A SOFFITTO - TRIDIMENSIONALE / 3D CEILING APPLICATION / APPLICATION AU PLAFOND - TRIDIMENSIONNELLE

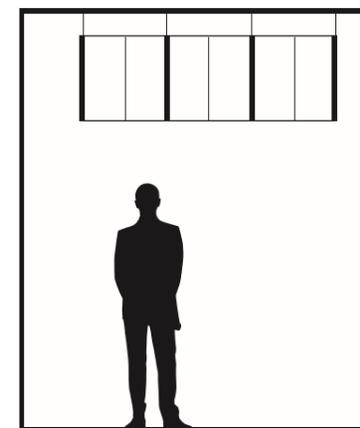

Sospensioni tridimensionali, regolari o irregolari, agganciate al soffitto mediante i componenti AIRFIX® direttamente o su binari in alluminio estruso, a vista o incasso, a seconda delle esigenze.

Three dimensional, regular or irregular suspended panels, attached to the ceiling with AIRFIX® components or on extruded aluminium rails, flush or surface-mounted depending on the customer's requirements.

Suspensions tridimensionnelles, régulières ou irrégulières, fixées directement au plafond à l'aide des composants AIRFIX® ou sur des rails en aluminium extrudé, apparents ou encastrés, en fonction des exigences.

## APPLICAZIONE A SOFFITTO / CEILING APPLICATION / APPLICATION AU PLAFOND

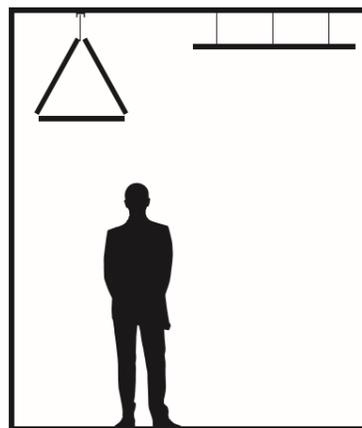

Composizioni geometriche articolate pensate per formare triangoli, quadrati, rettangoli, pentagoni, esagoni, verticali o orizzontali, ideali per moltiplicare la superficie di assorbimento e per arredare.

Structured geometric compositions designed to form vertical or horizontal triangles, squares, rectangles, pentagons, hexagons, ideal for increasing the room's absorption surface while decorating the walls.

Compositions géométriques articulées pensées pour former des triangles, carrés, rectangles, pentagones, hexagones, verticaux ou horizontaux, parfaits pour multiplier la surface d'absorption et pour décorer.

## APPLICAZIONE A CONTROSOFFITTO - TRIDIMENSIONALE / 3D FALSE CEILING APPLICATION / APPLICATION AU FAUX PLAFOND - TRIDIMENSIONNELLE

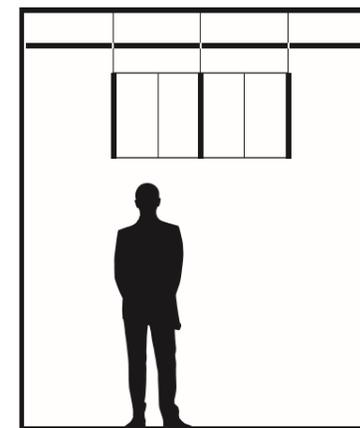

Sospensioni tridimensionali, agganciate ai controsoffitti modulari con appositi connettori del sistema AIRFIX®, in alternativa su binari in alluminio estruso, a vista o incasso, in base alle preferenze.

Three dimensional suspended panels attached to modular false ceilings with appropriate AIRFIX® connectors or extruded aluminium rails, flush or surface-mounted, based on the customer's preferences.

Suspensions tridimensionnelles, fixées aux faux plafonds modulaires avec les connecteurs spécifiques du système AIRFIX®, comme alternative sur des rails en aluminium extrudé, apparents ou encastrés, en fonction des préférences.

## APPLICAZIONE CON ILLUMINAZIONE / APPLICATION WITH LIGHTING / APPLICATION AVEC ÉCLAIRAGE

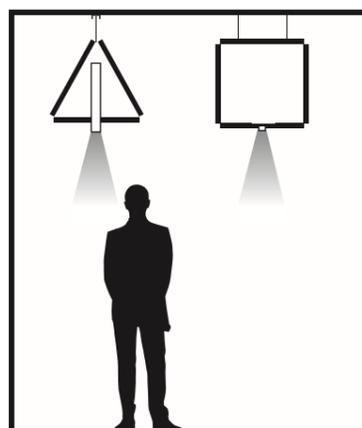

Corpi illuminanti a led integrati nei pannelli. Innovative "lampade acustiche". Piccoli spot o faretti, incassati o in appoggio, che creano semplici effetti di luce o illuminano in modo performante.

LED luminaires built into the panels. Innovative "acoustic lamps". Small recessed or surface-mounted spotlights, which create simple light effects or powerfully light up the room.

Luminaires à LED intégrés dans les panneaux. Innovantes « lampes acoustiques ». Petites lampes et petits spots, encastrés ou en appui, qui créent de simples effets de lumière et éclairent de façon performante.

## APPLICAZIONE A CONTROSOFFITTO CON ILLUMINAZIONE / FALSE CEILING APPLICATION WITH LIGHTING / APPLICATION AVEC ÉCLAIRAGE AU FAUX PLAFOND

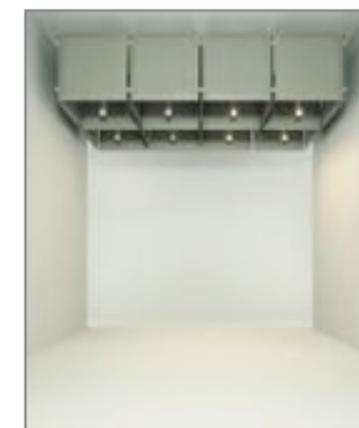
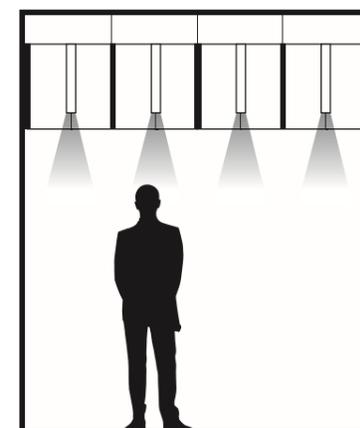

Corpi illuminanti a led integrati nelle composizioni tridimensionali di pannelli acustici. Semplici giochi di luce o elementi tecnici utili al raggiungimento della qualità illuminotecnica ambientale.

Luminaires built into three-dimensional compositions of acoustic panels. Simple light effects or technical elements to enhance the room with higher quality lighting technology.

Luminaires à LED intégrés dans les compositions tridimensionnelles de panneaux acoustiques. Simples jeux de lumière ou éléments techniques permettant d'obtenir la qualité illuminotecnica environnementale.



## AIR ON DESIGN

L'ESPERIENZA TECNICA DEL TEAM FONOLGY  
PER LA RICERCA DEL MIGLIOR DESIGN E DELLA  
MIGLIORE SOLUZIONE PER IL TUO PROGETTO

THE TECHNICAL EXPERTISE OF THE FONOLGY  
TEAM FOR THE PURSUIT OF THE BEST DESIGN  
AND OF THE BEST SOLUTION FOR YOUR PROJECT

L'EXPÉRIENCE TECHNIQUE DE L'ÉQUIPE FONOLGY  
POUR LA RECHERCHE DU MEILLEUR DESIGN ET DE  
LA MEILLEURE SOLUTION POUR VOS PROJETS



Air on Design è la famiglia di prodotti Air customizzabili per ogni tuo progetto.

Air on Design is the customisable Air product family for your every project.

Air on Design est une famille de produits Air adaptables à tous vos projets.

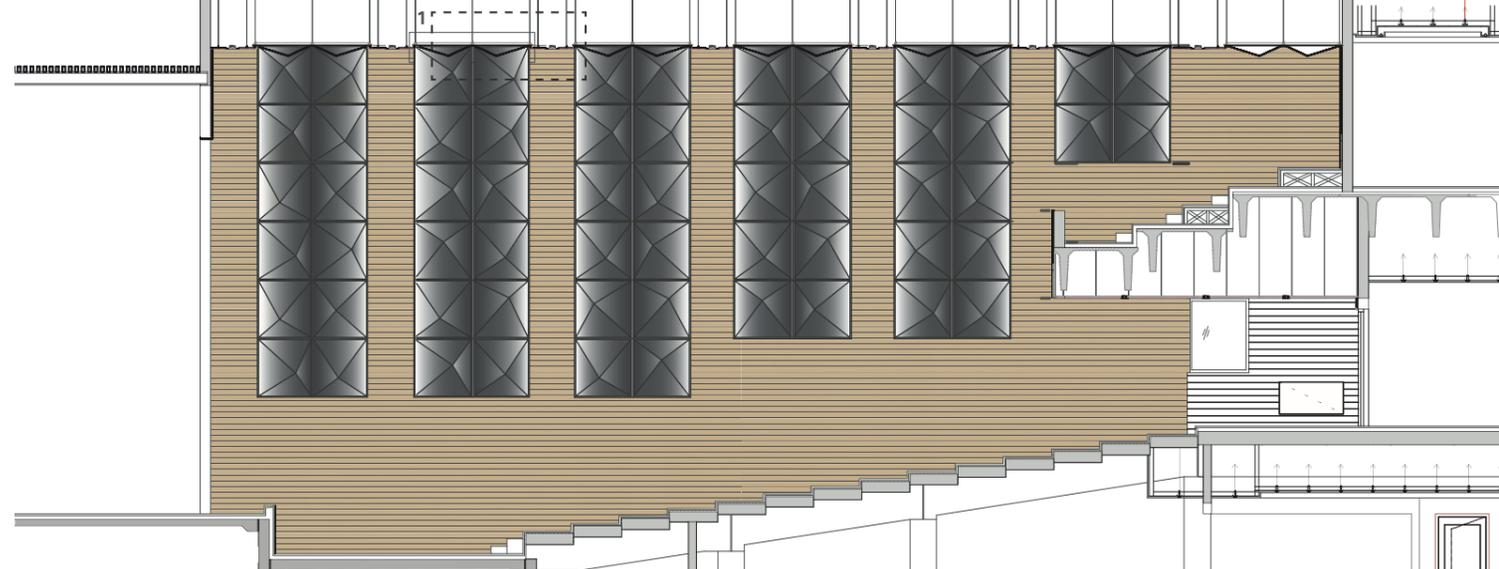

Sezione longitudinale / Longitudinal cross-section / Coupe en longueur

## > AIR ON DESIGN

### L'EVOLUZIONE DELLA FAMIGLIA AIR

Tutti i prodotti Air sono customizzabili per le tue esigenze di progetto. Partendo da un prodotto altamente performante in classe A, immagina di poter comporre liberamente senza limitare la tua creatività. Colori, forme tridimensionali e giochi di luce per esaltare il design innovativo: tutto ingegnerizzato e testato dal nostro team di esperti Fonology.

### CASE HISTORY: DASMAN SCHOOL

L'istituto internazionale bilingue Dasman è il centro educativo più all'avanguardia del Kuwait con le migliori tecnologie e professionalità al suo servizio. Il Cliente ha scelto di affidarsi all'esperienza Fonology non solo per la fornitura, ma anche per l'ideazione del concept e del progetto figurativo dell'auditorium principale di circa 570 posti. Fonology ha saputo vincere la sfida grazie ad un team di progettisti e tecnici esperti e competitivi che adotta un processo operativo suddiviso in 6 step principali:

- acquisizione dei desideri del Cliente e dei disegni esecutivi delle strutture.
- proposta del concept e progetto preliminare per il design della sala con approvazione.
- verifica, tramite modello acustico, dei tempi di riverbero delle parti fonoassorbenti da installare a soffitto e parete.
- ingegnerizzazione delle soluzioni estetiche approvate con presentazione di mock-up in scala 1:1 e render fotorealistici dell'auditorium.
- produzione e assemblaggio nelle nostre sedi in Italia.
- consegna e montaggio da parte di squadre esperte sotto la supervisione del project manager Fonology.

Questi 6 step sintetizzano un processo complesso e dinamico che si svolge sotto la guida di un capo progetto capace di interpretare e soddisfare le richieste del Cliente.

### THE EVOLUTION OF THE AIR FAMILY

All Air products can be customised to your specific design needs. Starting with a high-performance class A product, imagine being able to configure your creativity freely without limits. Colours, three-dimensional shapes and games of light to enhance the innovative design: everything is engineered and tested by our Fonology team of experts.

### CASE HISTORY: DASMAN SCHOOL

The Dasman international bilingual institute is the most sophisticated education centre in Kuwait, boasting the best technologies and professionalism. The Customer chose to rely on the experience of Fonology not only for the supply, but also for the concept design and the figurative project of the main auditorium with about 570 seats. Fonology successfully overcame this challenge thanks to a team of designers and competitive, technical experts who adopted an operational process divided into 6 major steps:

- acquisition of the customer's wishes and of the executive drawings of structures.
- proposal of the concept and preliminary project for the design of the room, with approval.
- verification, by means of an acoustic model, of the reverberation times of the sound-absorbing parts to install on the ceiling and walls.
- engineering of the approved aesthetic solutions with presentation of a mock-up in 1:1 scale and photo realistic rendering of the auditorium.
- production and assembly in our offices in Italy.
- delivery and installation by expert teams under the supervision of the Fonology project manager.

These 6 step sum up a complex, dynamic process that took place under the guidance of a project leader capable of interpret and accommodating the Customer's requests.

### L'EVOLUTION DE LA FAMILLE AIR

Tous les produits Air peuvent être adaptés aux exigences de votre projet. À partir d'un produit hautement performant de classe A, vous pouvez composer librement votre projet, sans limiter votre créativité. Les couleurs, les formes tridimensionnelles et les jeux de lumière exaltent son design innovant : le tout est élaboré et testé par notre équipe d'experts Fonology.

### ÉTUDE DE CAS : ÉCOLE DASMAN

L'institut international bilingue Dasman est le centre éducatif le plus avancé du Koweït. Il met ses dernières technologies et son professionnalisme à votre service. Le Client a choisi de faire confiance à l'expérience Fonology non seulement pour la fourniture, mais aussi pour l'imagination du concept et du projet préalable de l'auditorium principal d'environ 570 places. Fonology a su gagner la confiance du Client grâce à l'application par une équipe de concepteurs de projets et de techniciens experts et compétitifs d'un processus opérationnel divisé en 6 principales étapes :

- recueil des souhaits du Client et des dessins exécutifs des structures.
- proposition de concept et projet préliminaire pour la conception de la salle avec approbation.
- vérification, par le biais d'un modèle acoustique, des temps de réverbération des parties phonoabsorbantes à installer au plafond et aux murs.
- élaboration des solutions esthétiques approuvées avec présentation de maquette à l'échelle 1/1 et rendu photoréaliste de l'auditorium.
- production et assemblage au siège, en Italie.
- livraison et montage par une équipe experte, sous la supervision du responsable du projet Fonology.

Ces 6 étapes synthétisent un processus complexe et dynamique exécuté sous la direction d'un chef de projet capable d'interpréter et de satisfaire les demandes du Client.

1

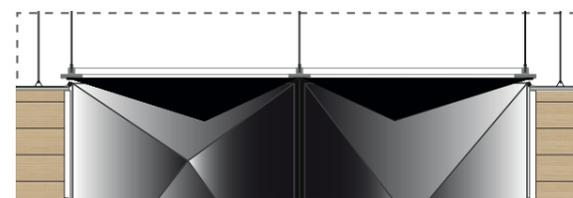

3

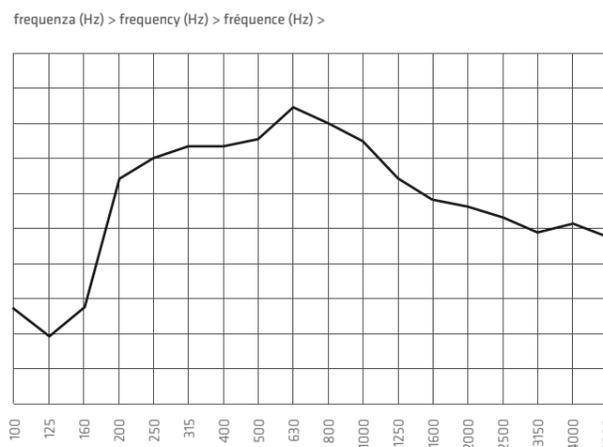

coefficiente di assorbimento acustico (α)  
sound absorption coefficient (α)  
coefficient d'absorption acoustique (α)

2

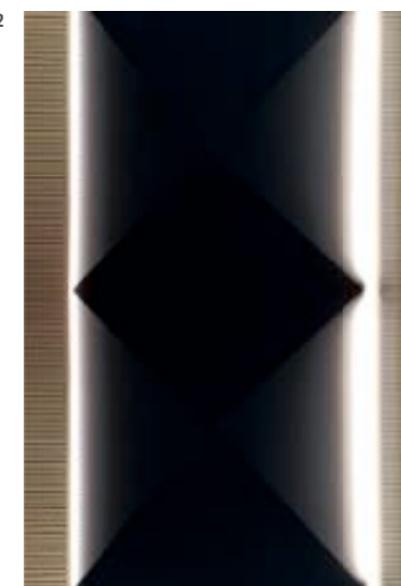

- Coefficiente di assorbimento acustico medio ponderato: (UNI EN ISO 354, UNI EN ISO 11654)  $\alpha_w = 0,7$  (montaggio distanziato 15 cm da parete)

La forma prismatica dei pannelli Airform aumenta la superficie di assorbimento e migliora le riflessioni casuali (random). L'utilizzo di Listen dogato aumenta l'assorbimento anche per le medie frequenze.

1 - Dettaglio di pannelli Air 3D fissati a soffitto.

2 - Foto di campione realizzato in scala 1:1 di pannello Air 3D con luci led e Listen dogato ai lati.

3 - Modello acustico dei tempi di riverbero dei pannelli fonoassorbenti prima dell'installazione

- Sound absorption coefficient medio ponderato: (UNI EN ISO 354, UNI EN ISO 11654)  $\alpha_w = 0,7$  (installazione a una distanza di 15 cm dal soffitto/muro)

The prismatic shape of the Airform panels increases the absorption surface and improves random reflections. The use of Listen stave panels increases the absorption also for medium frequencies.

1 - Detail of ceiling-mounted Air 3D panels.

2 - Photo of sample produced on a scale of 1:1 of Air 3D panel with LED lights and Listen stave panels on the sides.

3 - Acoustic model of reverberation times of the sound-absorbing panels before installation

- Coefficient d'absorption acoustique medio ponderato: (UNI EN ISO 354, UNI EN ISO 11654)  $\alpha_w = 0,7$  (montage à 15 cm de distance du plafond/mur)

La forme prismatique des panneaux Airform augmente la surface d'absorption et améliore les réflexions aléatoires. L'utilisation de Listen nervuré augmente encore l'absorption, même pour les fréquences moyennes.

1 - Détail des panneaux Air 3D fixés au plafond.

2 - Photo d'échantillon de panneau Air 3D réalisé à l'échelle 1/1, avec éclairage LED et Listen nervuré sur les côtés.

3 -Modèle acoustique des temps de réverbération des panneaux phonoabsorbants avant l'installation.

# EASY AIR

design: Simone Micheli

PANNELLO MODULARE FONDOASSORBENTE  
E TERMOISOLANTE REALIZZATO  
IN FIBRA DI POLIESTERE

MODULAR POLYESTER FIBRE PANEL  
FOR THERMAL AND  
ACOUSTIC INSULATION

PANNEAU MODULAIRE INSONORISANT  
ET THERMO-ISOLANT RÉALISÉ  
EN FIBRE DE POLYESTER

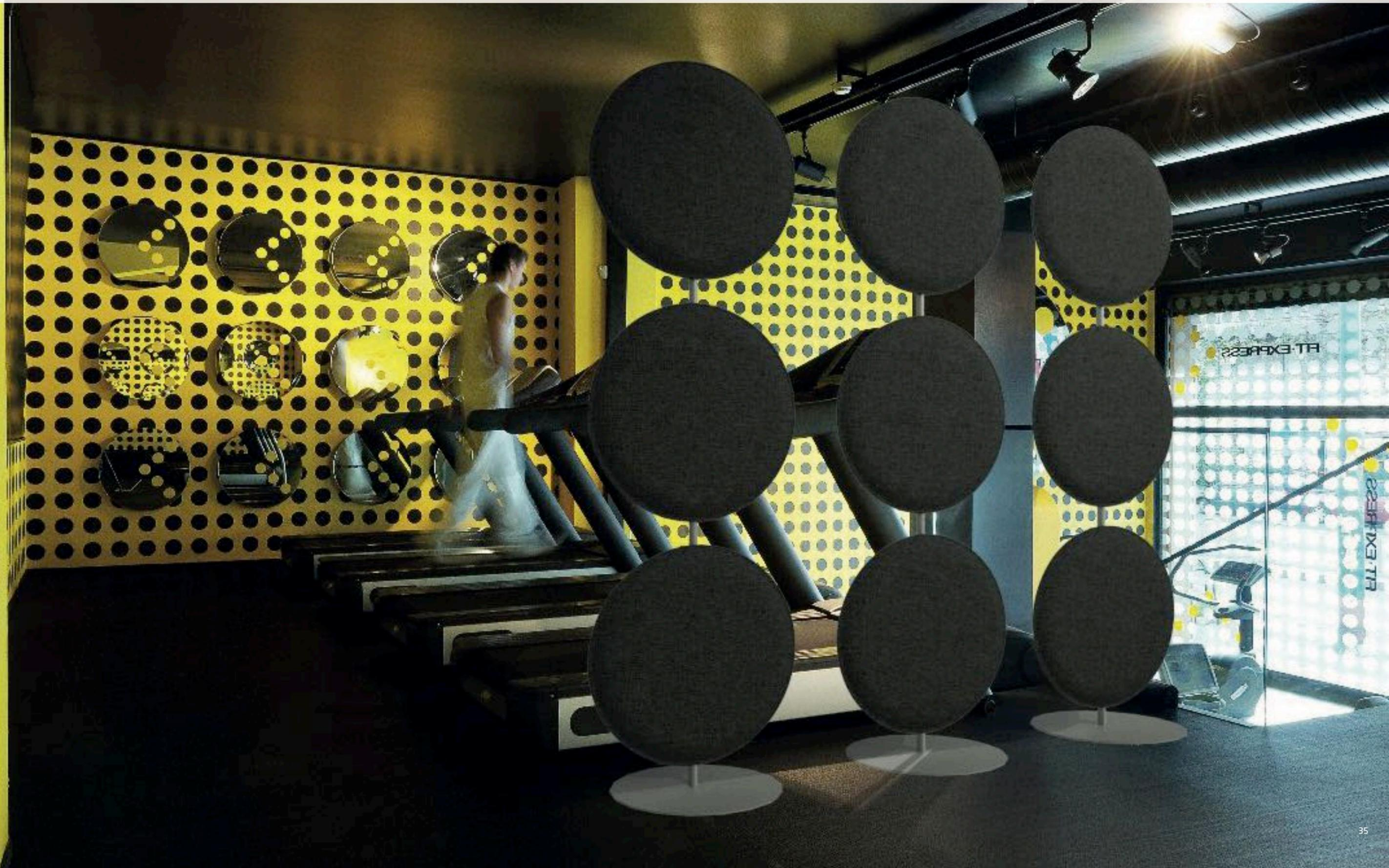

Easy air è composto da una percentuale di materiale (PET) riciclato.

Easy air contains a percentage of recycled material (PET).

Easy air se compose d'un pourcentage de matériau (PET) recyclé.

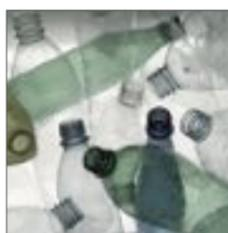

# > EASY AIR

design: Simone Micheli

## PER USARE AIRTWIN NELLA MASSIMA LIBERTÀ

Easy Air è la struttura metallica verniciata che, grazie al fissaggio tramite Aggancio Rapido®, consente la più facile installazione dei pannelli Airtwin rotondi o quadrati. Ideale come elemento divisorio facilmente rimovibile, Easy Air può essere spostato a piacere, non necessitando di alcun intervento strutturale. La possibilità di montare fino a nove pannelli garantisce un enorme potere fonoassorbente, arrivando a un abbattimento acustico del 35%.

## FOR USING AIRTWIN IN THE MOST VERSATILE WAY

Easy Air is a painted metal structure that allows very easy installation of round and square Airtwin panels thanks to fissaggio tramite Aggancio Rapido®. Ideal as an easy to remove partition, Easy Air can be moved as required, as there is no need for any structural intervention. The option of mounting up to nine panels guarantees high-performance acoustic insulation, reducing noise by 35%.

## POUR UTILISER AIRTWIN EN TOUTE LIBERTÉ OU BIEN

Easy Air est une structure métallique laquée qui, grâce aux fissaggio tramite Aggancio Rapido®, permet d'installer très facilement les panneaux Airtwin ronds ou carrés. Idéal comme élément de séparation facilement amovible, Easy Air peut être déplacé à volonté et ne nécessite aucune intervention structurelle. La possibilité de monter jusqu'à neuf panneaux garantit un pouvoir insonorisant énorme, se traduisant par une réduction du bruit de 35%.

**Dimensioni / Size / Dimensions:**  
Circolare / Round / Rond  
600 x 600 x 33 mm

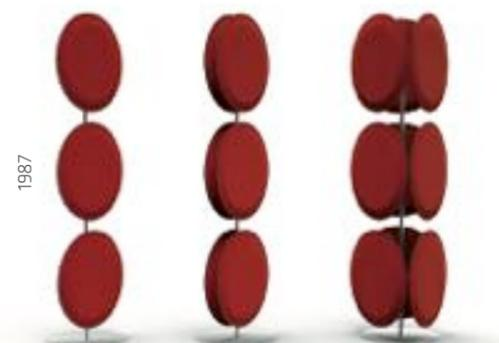
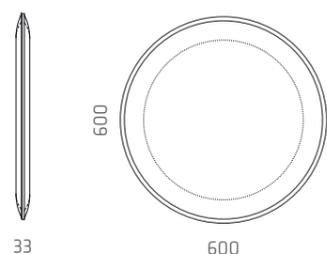

Ø 450  
monofacciale single-sided one face  
bifacciale double-sided deux faces  
trifacciale triple-sided trois faces

## Applicazione / Application / Application:

a parete o vetro, a soffitto, autoportante con o senza ruote. wall or glass, ceiling, stand alone with or without wheels. aux murs, aux vitres ou au sol, autoportant ou sans roues.

## DOVE E COME

Easy Air è perfetto come elemento divisorio fonoassorbente all'interno di un open space. Il pratico fissaggio tramite Aggancio Rapido® permette di sostituire e cambiare facilmente i pannelli, rinnovando in totale libertà le composizioni.

## SISTEMA DI FISSAGGIO

Aggancio Rapido®

## WHERE AND HOW

Easy Air is ideal as a soundproof partition in open spaces. The convenient mounting system using Aggancio Rapido® fittings enables the easy replacement of panels, renewing compositions in total freedom.

## MOUNTING SYSTEM

Aggancio Rapido®

## OÙ ET COMMENT

Easy Air est un élément de séparation insonorisant à l'intérieur des espaces ouverts. Le système de fixation pratique Aggancio Rapido® permet de remplacer et de changer facilement les panneaux, pour rénover les compositions en totale liberté.

## SYSTÈME DE FIXATION

Aggancio Rapido®

## Easy Air trifacciale / triple-side / trois faces

9 pannelli (2,52mq) fibra poliestere + tessuto Trevira. Installazione: freestanding. Norma di riferimento: UNI EN ISO 354: 2003 UNI EN ISO 11654: 1998.

9 polyester fibre panels (2,52mq) + Trevira fabric. Installation: freestanding. Reference standard: UNI EN ISO 354: 2003 UNI EN ISO 11654: 1998.

9 panneaux (2,52mq) fibre polyester + tissu Trevira. Installation: freestanding. Norme de référence: UNI EN ISO 354:2003 UNI EN ISO 11654:1998.

## Airtwin

1 mq di pannello in fibra di poliestere + tessuto Trevira. Installazione con intercapedine mm. 150. Norma di riferimento: UNI EN ISO 354: 2003 UNI EN ISO 11654: 1998.

1 mq di Polyester fibre panel + Trevira fabric. Installation with 150 mm air space. Reference standard: UNI EN ISO 354: 2003 UNI EN ISO 11654: 1998.

1 mq di Panneau fibre polyester + tissu Trevira. Installation avec double paroi 150 mm. Norme de référence: UNI EN ISO 354:2003 UNI EN ISO 11654:1998.

frequenza (Hz) > frequency (Hz) > fréquence (Hz) >

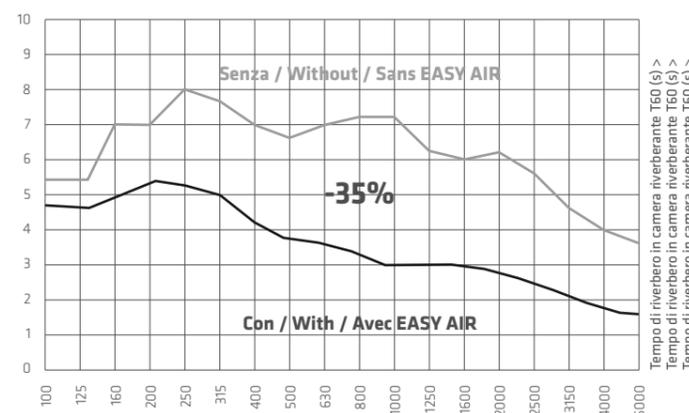

frequenza (Hz) > frequency (Hz) > fréquence (Hz) >

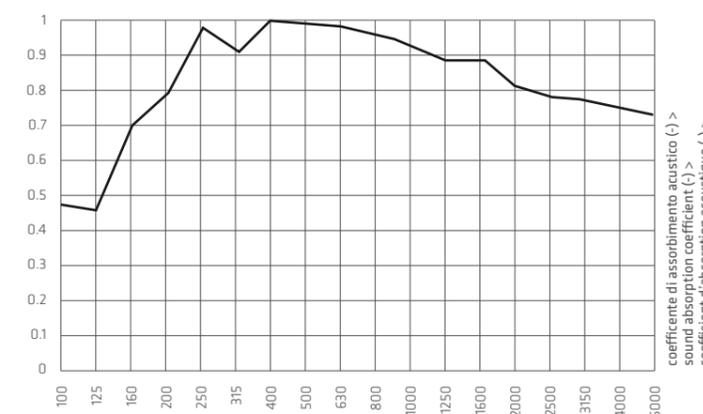

## Prodotto in CLASSE A

- Coefficiente di assorbimento acustico:  $\alpha_w=0.90$  Classe A (installazione distanziata 15cm da soffitto/parete)
- Densità 50 Kg/m<sup>3</sup>
- Conduttività:  $\lambda=0.0032$  W/mk (UNI EN 12664-02)
- Resistenza termica: 1.173 mqKW/1
- Reazione al fuoco: B s1 d0 (EN 13501-1; EN ISO 11925-2; EN 13823)
- Fattore di resistenza alla diffusione del vapore  $\mu=3.1$
- Classificazione fumi F1 (NF F 16-101)
- Certificazione VOC (UNI EN ISO 16000-9:2006, ISO 16000-6:2011)
- Tessuti certificati (confrontare cartella colori AresLine)

## Product in class A

- Sound absorption coefficient:  $\alpha_w=0.90$  (installation at a distance of 15cm of ceiling/wall)
- Density 50 Kg/m<sup>3</sup>
- Conductivity:  $\lambda=0.0032$  W/mk (UNI EN 12664-02)
- Thermal Resistance: 1.173 m<sup>2</sup>KW/1
- Reaction to fire: B s1 d0 (EN 13501-1; EN ISO 11925-2; EN 13823)
- Water vapour resistance factor  $\mu=3.1$
- Fire classification F1 (NF F 16-101)
- VOC certification (UNI EN ISO 16000-9:2006, ISO 16000-6:2011)
- Certified fabrics (compare Ares Line colour chart)

## Produit in class A

- Coefficient d'absorption acoustique:  $\alpha_w=0,90$  (fixation avec une distance de 15cm au plafond/mur),
- Densité 50 kg/m<sup>3</sup>
- Conductivité:  $\lambda=0.0032$  W/mk (UNI EN 12664-02)
- Résistance thermique: 1173 m<sup>2</sup>KW/1
- Réaction au feu: B s1 d0 (EN 13501-1; EN ISO 11925-2; EN 13823)
- Facteur de résistance à la diffusion de la vapeur  $\mu=3,1$
- Classification Fumée F1 (NF F 16-101)
- Certification VOC (UNI EN ISO 16000-9:2006, ISO 16000-6:2011)
- Tissus certifiés (consulter la palette de couleurs Ares Line)

## CARTELLA COLORI AIRTWIN AIRTWIN COLOUR CHART PALETTE DE COULEURS AIRTWIN



# LISTEN

MODULI FONOASSORBENTI IN MDF  
CON IMPIALLACCIATURA IN LEGNO  
A LAMELLE O QUADROTTE

SOUND-ABSORBING MDF MODULES  
WITH WOOD VENEER  
SLATS OR TILES

MODULES INSONORISANTS EN MDF  
AVEC PLACAGE EN LAMELLES  
OU EN CARRÉS DE BOIS



Listen è composto da una varietà di derivati del legno.

Listen consists of a number of wood products.

Listen se compose d'une variété de dérivés du bois.



# > LISTEN DOGATO

## L'EVERGREEN DEL BENESSERE

Il classico della fonoassorbente, l'elemento da cui si origina la storia dell'acustica architettonica.

L'effetto legno è un omaggio alla storicità, un evergreen dall'impatto visivo naturale, che unisce al benessere visivo il benessere acustico. Listen significa materiali e processi di produzione completamente ecocompatibili, per la massima riciclabilità.

## TIMELESS COMFORT

A traditional sound-absorbing element, used since the very beginning of the history of architectural acoustics.

Wood effect is a tribute to history, a timeless finish that creates a natural visual impact, combining visual and acoustic comfort. Listen is synonymous with environment-friendly production processes and materials to ensure highly recyclable products.

## L'ÉTERNEL DU BIEN-ÊTRE

Le classique de l'insonorisation, l'élément qui a donné naissance à l'histoire de l'acoustique architectonique. L'effet bois est un hommage à la dimension historique, un éternel de l'impact visuel naturel, qui allie le bien-être acoustique au bien-être visuel. Listen signifie matériaux et processus de production totalement respectueux de l'environnement, pour le maximum de recyclabilité.

### Dimensioni / Size / Dimensions:

Lamelle / Doghe std - Lam Std Slats - Lamelles / Lattes std: 4086 x 128 x 16 mm

### Tipologie:

liscio  
fresato non fonoassorbente  
fresato fonoassorbente

### Types:

smooth  
milling, non sound-absorbing  
milling, sound-absorbing

### Types :

lisse  
fraisé, non insonorisant  
fraisé, insonorisant

### Tipologie di Fresata / Milling patterns / Types de fraisage

Per forniture minori di 200mq, le fresature disponibili sono / for supplies of less than 200 square metres, the millings available are / pour les espaces de moins de 200 m<sup>2</sup>, les fraisages disponibles sont 9/2 - 14/2 - 13/3 - 28/4



## DOVE E COME

Perfetto negli ambienti più raffinati e classici, ma anche per esaltare con una cornice di eleganza arredamenti e tecnologie hi-tech. Versatile nell'installazione, consente l'applicazione su superfici "difficili", sia in parete sia come controsoffitto, dando libertà di forme davvero uniche per questo tipo di prodotto. La gamma delle finiture è vastissima, disponibile nel formato a doga (4086 x 128), di spessore 16mm.

Grazie al sistema di installazione Variofix, è completamente integrabile con tutta la gamma di pannelli Fonology o in pannelli modulari 600x600 a soffitto.

## WHERE AND HOW

Perfect for the most refined and classic environments, but also to enhance furnishings and hi-tech devices with an elegant frame. Designed to ensure high installation versatility, it can be applied to "difficult" surfaces, on either walls and false ceilings, creating a wide variety of unique shapes for this type of product.

A vast range of finishes is available in the slat size (4086 x 128), 16mm thick. With the Variofix installation system, it can be perfectly matched with the entire range of Fonology panels or 600x600 modular ceiling panels.

## OÙ ET COMMENT

Parfait dans les espaces les plus raffinés et classiques mais aussi pour exalter les ameublements et les technologies hi-tech avec un contexte d'élégance. Caractérisé par une installation polyvalente, il peut être appliqué sur des surfaces « difficiles », tant au mur que comme faux plafond, et permet de composer librement des formes vraiment uniques pour ce type de produit. La gamme de finitions est extrêmement vaste, disponible dans le format à latte (4086 x 128), de 16 mm d'épaisseur. Grâce au système d'installation Variofix, il se combine parfaitement avec toute la gamme de panneaux Fonology ou de panneaux modulaires 600 x 600 à fixer au plafond.

## CAMPIONE SOTTOPOSTO A PROVA

Pannello in MDF mod. Listen 40/2 con intercapedine riempita di pannelli in fibra di poliestere densità 40/m<sup>3</sup> spessore 20 mm. Installazione in aderenza. Norma di riferimento: UNI EN ISO 354: 2003 UNI EN ISO 11654: 199

## SAMPLE TESTED

MDF panel mod. Listen 40/2 with air gap filled with polyester fibre panels, density 40/m<sup>3</sup>, 20 mm thick. Flush installation. Reference standard: UNI EN ISO 354: 2003 UNI EN ISO 11654: 199

## ÉCHANTILLON SOUMIS À ESSAIS

Panneau en MDF mod. Listen 40/2 avec double paroi remplie de panneaux en fibre de polyester densité 40/m<sup>3</sup>, épaisseur 20 mm. Installation adhérente. Norme de référence : UNI EN ISO 354:2003 UNI EN ISO 11654:199

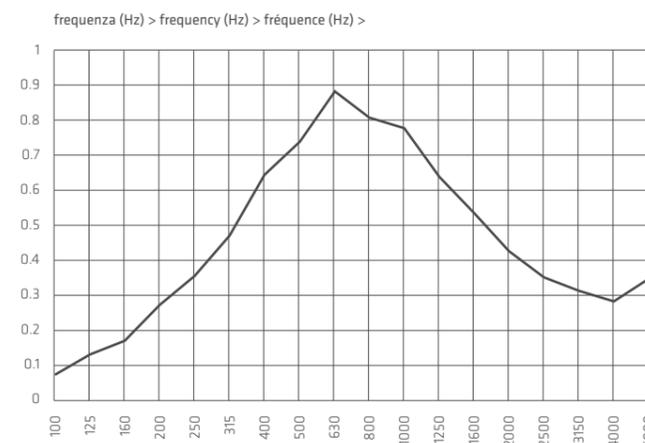

## SCHEDA TECNICA

Pannello MDF di spessore 16 mm, con finitura melaminica, legno, laccato o laminato.

- Densità pannello MDF: 760 kg/m<sup>3</sup> (EN 323)
- Formaldeide: classe E1 (EN 120)

## SU RICHIESTA

- Reazione al fuoco (EN 13501-1)
- Certificazione CE (B-s2, d0)
- Vernice IGNIFUGA in classe 1
- Classificazione E1 secondo EN 717-1 e F 4\*\*\*\* secondo JIS A 1460 per le emissioni di formaldeide

## SISTEMA DI AGGANCIO

VARIOFIX a parete e a soffitto.

## DATA SHEET

16 mm thick MDF panel with melamine, wood, lacquered or laminated finish.

- MDF panel density: 760 kg/m<sup>3</sup> (EN 323)
- Formaldehyde: class E1 (EN 120)

## ON REQUEST

- Reaction to fire (EN 13501-1)
- Certification EC (B-s2, d0)
- FIREPROOF paint in class 1
- E1 classification according to EN 717-1 and F 4\*\*\*\* according to JIS A 1460 for formaldehyde emissions

## MOUNTING SYSTEM

Wall and ceiling VARIOFIX.

## FICHE TECHNIQUE

Panneau MDF de 16 mm d'épaisseur, avec finition mélaminé, bois, laqué ou laminé.

- Densité panneau MDF: 760 kg/m<sup>3</sup> (EN 323)
- Formaldéhyde: classe E1 (EN 120)

## SUR DEMANDE

- Réaction au feu (EN 13501-1)
- Certification CE (B-s2, d0)
- Peinture IGNIFUGE en classe 1
- Classification E1 selon les normes EN 717-1 et F 4\*\*\*\* et JIS A 1460 pour les émissions de formaldéhyde

## SYSTÈME DE FIXATION

VARIOFIX au mur et au plafond.

## FINITURE MELAMINICO MELAMINE FINISHES FINITIONS EN MÉLAMINÉ

	MBN avorio ivory ivoire
	MAF acero maple érable
	MWE wengè wengè wengè
	MAR alluminio aluminium aluminium
	MBS bianco blank blanc
	MGS grigio grey gris
	MRL rovere oak chêne
	MTK teak teak teak
	MGZ grezzo raw brute

## FINITURE LEGNO WOOD FINISHES FINITIONS BOIS

	WBT betulla birch bouleau
	WFG faggio beech hêtre
	WRF frassino ash frêne
	WRV rovere oak chêne
	WAC acero maple érable
	WLA larice larch mélèze
	WNN noce nazionale national walnut noyer national
	WCA ciliegio americano american cherry cerisier américain
	WCE ciliegio europeo european cherry cerisier européenne

Disponibile laccatura acrilica colori RAL. Laminato disponibilità a progetto.

Available with acrylic lacquer finish in RAL colours. Laminated finish available on request, after submitting project drawing.

Laquage acrylique couleurs RAL disponible. Laminé disponibilité sur présentation du projet.

Listen è in MDF. La materia prima utilizzata comprende molti tipi di legno.

Listen is made of MDF. The raw material used includes many types of wood.

Listen est fabriqué en MDF. La matière première utilisée comprend de nombreux types de bois.



## > LISTEN SQUARE

### LEGNO AL SOFFITTO

Il soffitto ha trovato il suo rivestimento naturale. Listen Square offre la possibilità di sfruttare il soffitto per correggere il ritorno acustico di uno spazio. Per arricchire e ottimizzare dal punto di vista estetico e sonoro un ambiente, lasciandone inalterate le pareti.

### WOOD CEILINGS

Ceilings have found their most natural finish. Listen Square offers the opportunity to use the ceiling to reduce echo and reverberation, so as to enhance and optimise a room's visual impact and acoustic performance, without changing the walls.

### BOIS AU PLAFOND

Le plafond a trouvé son revêtement naturel. Listen Square offre la possibilité d'utiliser le plafond pour corriger le retour acoustique d'un espace. Pour enrichir et optimiser un espace du point de vue esthétique et sonore, sans altérer les murs.

### Dimensioni / Size / Dimensions:

600 x 600 x 18 mm  
1200 x 600 x 18 mm

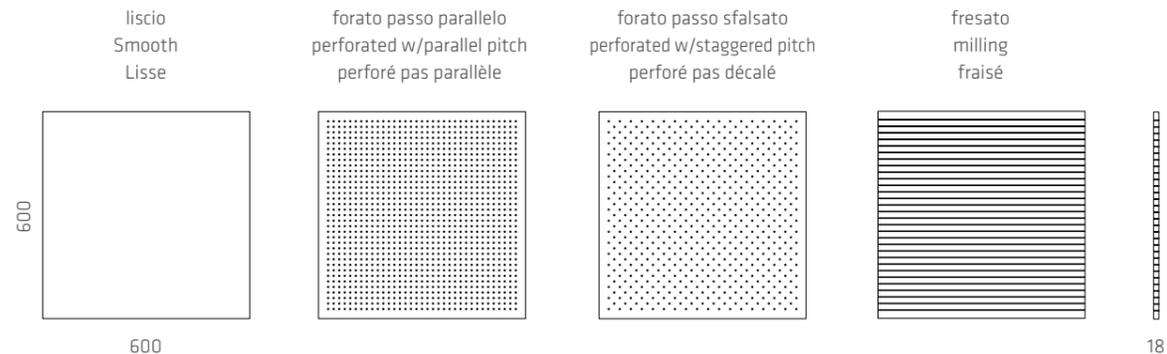

### Tipologie:

**LISCIO**  
MICRO FORATO  
Microforo Ø 1,2 mm  
FORATO  
Forato Ø 3 mm passo 16 mm fori paralleli  
Forato Ø 3 mm passo 32 mm fori paralleli  
Forato Ø 3 mm passo 32 mm fori falsati  
Forato Ø 5 mm passo 16 mm fori paralleli  
Forato Ø 8 mm passo 32 mm fori falsati  
Forato Ø 10 mm passo 32 mm fori paralleli  
Forato Ø 20 mm passo 64 mm fori paralleli  
Forato Ø 20 mm passo 64 mm fori falsati  
FRESATO  
Stesse finiture di LISTEN DOGATO

### Types:

**SMOOTH**  
MICRO PERFORATED  
Micro hole Ø 1.2 mm  
PERFORATED  
Hole Ø 3 mm, 16 mm pitch, parallel holes  
Hole Ø 3 mm, 32 mm pitch, parallel holes  
Hole Ø 3 mm, 32 mm pitch, staggered holes  
Hole Ø 5 mm, 16 mm pitch, parallel holes  
Hole Ø 8 mm, 32 mm pitch, staggered holes  
Hole Ø 10 mm, 32 mm pitch, parallel holes  
Hole Ø 20 mm, 64 mm pitch, parallel holes  
Hole Ø 20 mm, 64 mm pitch, staggered holes  
MILLING  
Same finishes as LISTEN DOGATO panels

### Types :

**LISSE**  
MICRO PERFORÉ  
Micro perforation Ø 1,2 mm  
PERFORÉ  
Perforé Ø 3 mm pas 16 mm perforations parallèles  
Perforé Ø 3 mm pas 32 mm perforations parallèles  
Perforé Ø 3 mm pas 32 mm perforations décalés  
Perforé Ø 5 mm pas 16 mm perforations parallèles  
Perforé Ø 8 mm pas 32 mm perforations décalés  
Perforé Ø 10 mm pas 32 mm perforations parallèles  
Perforé Ø 20 mm pas 64 mm perforations parallèles  
Perforé Ø 20 mm pas 64 mm perforations décalés  
FRAISÉ  
Mêmes finitions que LISTEN DOGATO

### CAMPIONE SOTTOPOSTO A PROVA

Pannello in MDF mod. Listen SQUARE Ø 5  
Passo 16 con intercapedine h.200 mm.  
riempita di pannelli in fibra di poliestere densità 40/Kg/m3 spessore 100 mm.

### SAMPLE TESTED

MDF panel mod. Listen SQUARE Ø 5  
16 mm pitch with h.200 mm. air space filled with polyester fibre panels, density 40/Kg/m3, 100 mm thick.

### ÉCHANTILLON SOUMIS À ESSAIS

Panneau en MDF mod. Listen SQUARE Ø 5  
Pas 16 avec double paroi h. 200 mm remplie de panneaux en fibre de polyester, densité 40 kg/m3, épaisseur 100 mm.

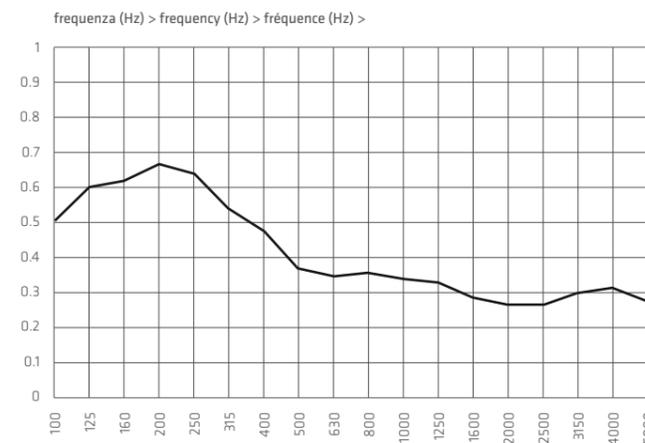

coefficiente di assorbimento acustico (α) >  
sound absorption coefficient (α) >  
coefficient d'absorption acoustique (α) >

### SCHEDA TECNICA

Pannello MDF sp. 16 mm  
finitura melaminica, legno, laccato o laminato.

- Densità pannello MDF: 760 kg/m3 (EN 323)
- Formaldeide: classe E1 (EN 120)

### SU RICHIESTA

- Reazione al fuoco (EN 13501-1)
- Certificazione CE (B-s2, d0)
- Vernice IGNIFUGA in classe 1
- Classificazione E1 secondo EN 717-1 e F 4\*\*\*\* secondo JIS A 1460 per le emissioni di formaldeide

### SISTEMA DI AGGANCIO

VARIOFIX, T24 e SILHOUETTE a parete e a soffitto.

### DATA SHEET

16 mm thick MDF panel melamine, wood, lacquer or laminated finish.

- MDF panel density: 760 kg/m3 (EN 323)
- Formaldehyde: class E1 (EN 120)

### ON REQUEST

- Reaction to fire (EN 13501-1)
- Certification EC (B-s2, d0)
- FIREPROOF paint in class 1
- E1 classification according to EN 717-1 and F 4\*\*\*\* according to JIS A 1460 for formaldehyde emissions

### MOUNTING SYSTEM

Wall and ceiling VARIOFIX, T24 and SILHOUETTE.

### FICHE TECHNIQUE

Panneau MDF ép. 16 mm finition mélaminé, bois, laqué ou laminé.

- Densité panneau MDF : 760 kg/m3 (EN 323)
- Formaldéhyde: classe E1 (EN 120)

### SUR DEMANDE

- Réaction au feu (EN 13501-1)
- Certification CE (B-s2, d0)
- Peinture IGNIFUGE en classe 1
- Classification E1 selon les normes EN 717-1 et F 4\*\*\*\*, et JIS A 1460 pour les émissions de formaldéhyde

### SYSTÈME DE FIXATION

VARIOFIX, T24 et SILHOUETTE au mur et au plafond.

### FINITURE MELAMINICO MELAMINE FINISHES FINITIONS EN MÉLAMINÉ

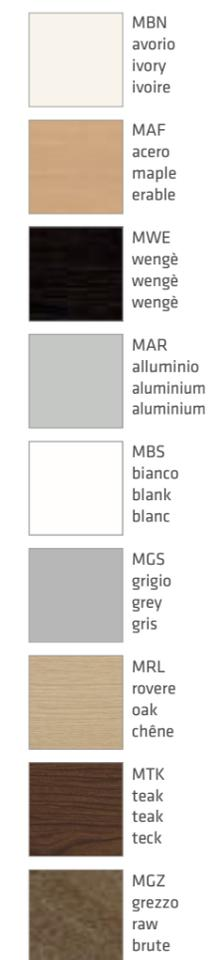

### FINITURE LEGNO WOOD FINISHES FINITIONS BOIS



Disponibile laccatura acrilica colori RAL. Laminato disponibilità a progetto.

Available with acrylic lacquer finish in RAL colours. Laminated finish available on request, after submitting project drawing.

Laquage acrylique couleurs RAL disponible. Laminé disponibilité sur présentation du projet.

Listen extra: l'evoluzione materica incontra anche il legno.

Listen extra: the textured evolution also involves wood.

Listen extra: l'évolution de la matière à la rencontre du bois



## > LISTEN EXTRA

### LA MATERIA AL DI LA' DEL LEGNO

Il pannello acustico per eccellenza si veste di nuovo: vernici metalliche e rivestimenti superficiali donano nuova vita al legno listen. Tante le proposte e ancora di più le soluzioni su misura per creare superfici non convenzionali.

Vernici o applicazioni artigianali di pregiati metalli da sovrapporre al listen dogato con qualsiasi tipologia di fresata per non rinunciare mai al benessere acustico perfetto per il tuo ambiente.

### DIMENSIONI E SCHEDA TECNICA.

conforme alle caratteristiche espresse per Listen dogato.

### MATERIAL BEYOND WOOD

The acoustic panel par excellence has been restyled: metallic paints and surface coverings give Listen wood a new lease of life. Plenty of solutions and even more bespoke solutions to create unconventional surfaces.

Paints or craft-based applications of precious metals to overlay on Listen stave panels with any type of milling, to avoid ever foregoing the perfect acoustic comfort for your environment.

### DIMENSIONS AND TECHNICAL DATA SHEET.

conforms to the characteristics expressed for Listen stave panels.

### LA MATIERE AU-DELA DU BOIS

Le panneau acoustique par excellence se revêt de nouveau : peintures métalliques et revêtements superficiels donnent une nouvelle vie au bois Listen. Les possibilités sont nombreuses tout autant que les solutions sur mesure pour créer des espaces non conventionnels. Peintures ou application artisanale de métaux précieux à superposer au Listen nervuré avec tout type de fraisage, pour ne jamais renoncer au bien-être acoustique adapté à votre environnement.

### DIMENSIONS ET FICHE TECHNIQUE.

conforme aux caractéristiques indiquées pour le Listen nervuré.



FOGLIA ORO 24K / 24K GOLD LEAF / FEUILLE D'OR 24 K



PIOMBO IN FUSIONE / CAST LEAD / PLOMB EN FUSION



PELTRO ANTICATO SATINATO / SATIN FINISH DISTRESSED PEWTER / ÉTAIN VIEILLI SATINÉ



PELTRO / PEWTER / ÉTAIN



ARGENTO LIMATO INCROCIATO / TRIMMED CRISS-CROSSING SILVER / ARGENT BROSSÉ CROISÉ



ARGENTO SATINATO / SATIN FINISH SILVER / ARGENT SATINÉ



BRONZO ANTICATO / DISTRESSED BRONZE / BRONZE VIEILLI



BRONZO SATINATO / SATIN FINISH BRONZE / BRONZE SATINÉ



RAME ANTICATO / DISTRESSED COPPER / CUIVRE VIEILLI



RAME LUCIDO / POLISHED COPPER / CUIVRE BRILLANT



NICHEL / NICKEL / NICKEL

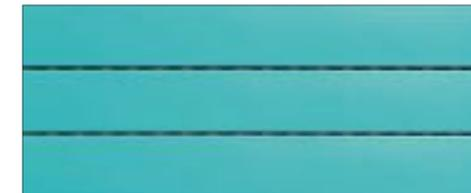

VERNICE METALLIZZATA / METALLIC PAINT / PEINTURE MÉTALLISÉE

### VERNICI EFFETTO CEMENTO

È un processo accurato e artigianale. Dopo la fase iniziale di preparazione del fondo e verniciatura, artigiani esperti lavorano la superficie dandogli quel senso di movimento e materia tipici del vero cemento.

### CONCRETE LOOK PAINTS

It is a painstaking craft-based process. After the initial phase of preparing the primer and painting, skilled craftsmen work the surface, giving that sense of motion and texture typical of real concrete.

### PEINTURE EFFET CIMENT

Il s'agit d'un processus soigné et artisanal. Après la phase initiale de préparation du fond et de peinture, les artisans experts travaillent sur la surface, pour lui donner cette impression de mouvement et de matière authentique typique du véritable ciment.



CEMENTO SCURO / DARK CONCRETE / CIMENT SOMBRE



CEMENTO CHIARO / CIMENT CLAIR / PALE CONCRETE

# CONCRETECH

MODULI IN PANNELLO FORATO IN MDF  
CON FINITURA SUPERFICIALE  
IN ECOMALTA

MDF PERFORATED PANEL  
MODULES WITH ECOMALTA  
SURFACE FINISH

MODULES EN PANNEAU PERFORÉ  
EN MDF AVEC FINITION  
DE SURFACE EN ECOMALTA



Concretech ha una superficie di ecomalta

Concretech features a ecomalta surface

Concretech a une surface de ecomalta



## > CONCRETECH

### LA VOCE DELLA MATERIA

La finitura inedita nel mondo della fono assorbenza. Grazie a questi pannelli speciali è possibile vivere l'effetto cemento in tutta la sua matericità con Ecomalta. Materiale innovativo, ecologico, privo di cemento, calce, resine epossidiche e sostanze tossiche sia per l'uomo, sia per l'ambiente. I pannelli sono realizzati in modo sartoriale, esaltando la manualità dell'uomo con un ciclo studiato appositamente per ambienti di carattere e non convenzionali. Per la massima forza espressiva, sia estetica sia sonora.

### THE VOICE OF MATERIAL

The unprecedented finish in the world of sound-absorption. Thanks to these special panels, you can enjoy the concrete look in all its appealing texture with Ecomalta. An innovative, eco-friendly material, devoid of cement, lime, epoxy resins and toxic substances for both human beings and for the environment. The panels are tailor-made, to enhance manual dexterity with a cycle designed specifically for distinguished, unconventional environments. For maximum expressive force, both aesthetic and sound.

### LA VOIX DE LA MATIÈRE

Une finition unique dans le monde de l'absorption phonique. Grâce à ces panneaux spéciaux, Ecomalta permet de faire l'expérience parfaite de la matière du ciment. Matériau innovant, écologique, sans ciment, chaux, résines époxydiques, ni substances toxiques pour l'homme comme pour l'environnement. Les panneaux sont réalisés sur mesure et soulignent l'habileté manuelle de l'homme d'après une méthode étudiée spécifiquement pour les environnements de caractère et non conventionnels. Pour une force d'expression maximale, aussi esthétique qu'acoustique.

### Dimensioni / Size / Dimensions:

600 x 600 x 18 mm  
1200 x 600 x 18 mm

grana fine o ruvida  
fine or coarse grain  
grain fin ou rugueux

forato passo parallelo  
perforated w/ paralld pitch  
perforé parallèle

forato passo sfalsato  
perforated w/ staggered pitch  
perforé décalé

fresato  
milling  
fraisé



600

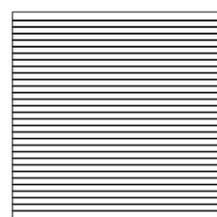
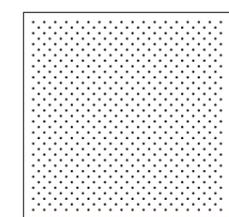
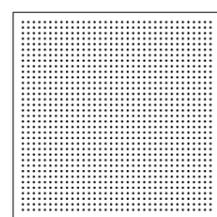

18

### Tipologie:

GRANA FINE O RUVIDA

#### FORATO

Foro Ø 4 mm passo 16 mm fori paralleli  
Foro Ø 4 mm passo 16 mm fori sfalsati  
Foro Ø 4 mm passo 32 mm fori paralleli  
Foro Ø 4 mm passo 32 mm fori sfalsati  
Foro Ø 8 mm passo 32 mm fori paralleli  
Foro Ø 8 mm passo 32 mm fori sfalsati

#### FRESATO

Fresatura 19/2

### Types:

FINE OR COARSE GRAIN

#### PERFORATED

Hole Ø 4 mm, 16 mm pitch, parallel holes  
Hole Ø 4 mm, 16 mm pitch, staggered holes  
Hole Ø 4 mm, 32 mm pitch, parallel holes  
Hole Ø 4 mm, 32 mm pitch, staggered holes  
Hole Ø 8 mm, 32 mm pitch, parallel holes  
Hole Ø 8 mm, 32 mm pitch, staggered holes

#### MILLING

19/2 routing

### Types:

GRAIN FIN OU RUGUEUX

#### PERFORÉ

Perforation Ø 4 mm pas 16 mm orifices parallèles  
Perforation Ø 4 mm pas 16 mm orifices décalés  
Perforation Ø 4 mm pas 32 mm orifices parallèles  
Perforation Ø 4 mm pas 32 mm orifices décalés  
Perforation Ø 8 mm pas 32 mm orifices parallèles  
Perforation Ø 8 mm pas 32 mm orifices décalés

#### FRAISÉ

Fraisage 19/2

### CAMPIONE SOTTOPOSTO A PROVA

Pannello Mdf + Ecomalta.

Foro Ø 4 mm, passo 16 mm sfalsato.

Installazione in aderenza. Norma di riferimento:

UNI EN ISO 354: 2003 - UNI EN ISO 11654:

199.

### SAMPLE TESTED

Mdf panel + Ecomalta.

Hole Ø 4 mm, 16 mm staggered pitch.

Flush installation. Reference standard:

UNI EN ISO 354: 2003 - UNI EN ISO 11654:

199.

### ÉCHANTILLON SOUMIS À ESSAIS

Panneau MDF + Ecomalta.

Orifice Ø 4 mm, pas 16 mm décalé.

Installation adhérente. Norme de référence :

UNI EN ISO 354:2003 - UNI EN ISO 11654:199.

FINITURE SU RICHIESTA,  
ALCUNI ESEMPLI /  
FINISHES UPON REQUEST,  
A FEW EXAMPLES /  
FINITIONS SUR DEMANDE,  
QUELQUES EXEMPLES

frequenza (Hz) > frequency (Hz) > fréquence (Hz) >

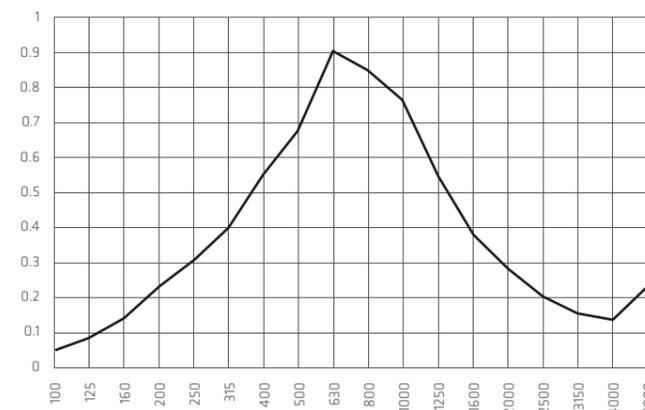

coefficiente di assorbimento acustico (α) >  
sound absorption coefficient (α) >  
coefficient d'absorption acoustique (α) >

### DOVE E COME

Completamente integrabile con la gamma di pannelli Fonology, consentendo la realizzazione di finiture multimateriche di grande effetto, con performances acustiche di eccellenza alle frequenze del parlato. Le fresature frontali, come i fori di diverse dimensioni e passi paralleli o sfalsati, rendono Concretech perfettamente adattabile a qualsiasi tipo di ambiente. Ogni luogo diventa unico e di tendenza, soddisfacendo qualsiasi esigenza di arredo e di stile.

### WHERE AND HOW

Perfectly matched with the whole range of Fonology panels, it creates striking multi-material finishes, providing excellent acoustic performance for voice frequencies. The routing on the front side of the panel, as well as holes of different sizes and parallel or staggered pitches, make Concretech ideal for any type of environment. Each place becomes unique with a contemporary and trendy vibe, satisfying every need in terms of decoration and style.

### OÙ ET COMMENT

Parfaitement combinable avec la gamme de panneaux Fonology, permettant ainsi de réaliser des finitions multimatérielles spectaculaires, avec d'excellentes performances acoustiques aux fréquences de conversation. Les fraisages frontaux, comme les orifices de différentes dimensions et les pas parallèles ou décalés, permettent d'adapter parfaitement Concretech à tous les types d'ambiance. Chaque lieu devient unique et à la mode, en satisfaisant toutes les exigences d'ameublement et de style.

### SCHEDA TECNICA

Pannello MDF sp. 16 mm rivestito con ecomalta sul lato a vista sp. 2 mm circa. Su richiesta pannelli in mdf ignifugo classe 1 secondo normativa CE classe 1 di reazione al fuoco (B, s2, d0)

### DATA SHEET

16 mm thick MDF panel lined with 2 mm thick ecomalta on visible side. Upon request, fireproof MDF panels class 1 according to EC Regulation, reaction to fire (B, s2, d0)

### SISTEMA DI AGGANCIO

BRICK SYSTEM a parete.  
SILHOUETTE a soffitto.

### MOUNTING SYSTEM

Wall BRICK SYSTEM.  
Ceiling SILHOUETTE.

### FICHE TECHNIQUE

Panneau MDF ép. 16 mm revêtu de ecomalta sur le côté apparent, ép. 2 mm. Sur demande, panneaux en MDF ignifuge classe 1 selon la réglementation CE classe 1 de réaction au feu (B, s2, d0)

### SYSTÈME DE FIXATION

BRICK SYSTEM au mur.  
SILHOUETTE au plafond.



# PETRA

MODULI IN PANNELLO FORATO IN MDF  
CON FINITURA SUPERFICIALE  
IN ARDESIA

MDF PERFORATED PANEL  
MODULES WITH NATURAL  
STONE SURFACE FINISH

MODULES EN PANNEAU PERFORÉ  
EN MDF AVEC FINITION  
DE SURFACE EN ARDOISE



Petra ha una superficie di ardesia

Petra features a natural stone surface

Petra a une surface de ardoise



# > PETRA

## THE SOUND OF A ROCK

Un'altra finitura Fonology totalmente rivoluzionaria nell'ambito dei rivestimenti fonoassorbenti: l'ardesia. Vera roccia ricopre il materiale in fibra ad alte prestazioni acustiche. Il suono si propaga al meglio in ogni ambiente grazie all'ottimizzazione di questo materiale inedito. Per unire al massimo comfort sonoro la grande forza estetica della pietra naturale.

## THE SOUND OF A ROCK

Slate is another revolutionary finish offered by Fonology in the field of soundproofing materials. Featuring high acoustic performance, the fiber material is covered by true rock. Sound propagates perfectly in any room through the optimisation provided by this innovative material, combining acoustic comfort and the powerful aesthetic impact of natural stone.

## THE SOUND OF A ROCK

Une autre finition Fonology totalement révolutionnaire dans le domaine des revêtements insonorisants : l'ardoise. De la roche véritable recouvre le matériau en fibre à hautes performances acoustiques. Le son se propage au mieux dans tous les espaces grâce à l'optimisation de ce matériau inédit. Pour allier le maximum de confort acoustique à la grande force esthétique de la pierre naturelle.

**Dimensioni / Size / Dimensions:**  
600 x 600 x 18 mm  
1200 x 600 x 18 mm

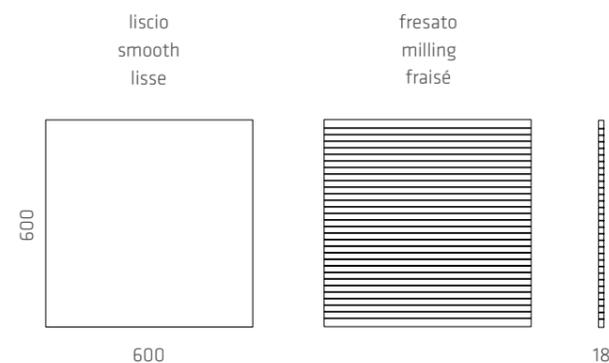

### Tipologie:

LISCIO  
FRESATO  
Fresatura 19/2  
Fresatura 40/2

### Types:

SMOOTH  
MILLING  
19/2 routing  
40/2 routing

### Types:

LISSE  
FRAISÉ  
Fraisage 19/2  
Fraisage 40/2

## CAMPIONE SOTTOPOSTO A PROVA

Pannello in MDF + ardesia.  
Fresato 19/2.  
Installazione in aderenza. Norma di riferimento:  
UNI EN ISO 354: 2003 - UNI EN ISO 11654: 199

## SAMPLE TESTED

MDF panel mod. + natural stone.  
Milling 19/2.  
Flush installation. Reference standard:  
UNI EN ISO 354: 2003 - UNI EN ISO 11654: 199

## ÉCHANTILLON SOUMIS À ESSAIS

Panneau MDF + ardoise.  
Fraisé 19/2.  
Installation adhérente. Norme de référence :  
UNI EN ISO 354:2003 - UNI EN ISO 11654:199

## FINITURE SU RICHIESTA, ALCUNI ESEMPI / FINISHES UPON REQUEST, A FEW EXAMPLES / FINITIONS SUR DEMANDE, QUELQUES EXEMPLES

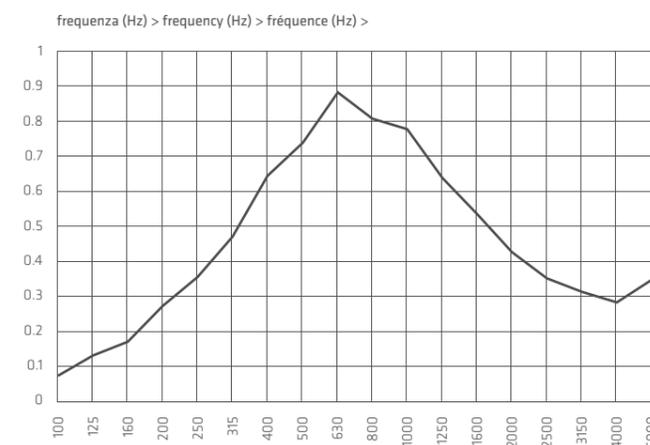

coefficiente di assorbimento acustico (α) >  
sound absorption coefficient (α) >  
coefficient d'absorption acoustique (α) >

## DOVE E COME

Completamente integrabile con la gamma di pannelli Fonology, consentendo la realizzazione di finiture multimateriche di grande effetto, con performances acustiche di eccellenza alle frequenze del parlato. Petra riveste con stile ambienti moderni, dove la matericità è al centro del progetto. L'aspetto rugoso esalta la veridicità del rivestimento.

## WHERE AND HOW

Perfectly matched with the whole range of Fonology panels, it creates striking multi-material finishes, providing excellent acoustic performance for voice frequencies. Petra adorns modern settings with style, where texture plays the starring role of the design. The rough appearance enhances the genuineness of the covering.

## OÙ ET COMMENT

Parfaitement combinable avec la gamme de panneaux Fonology, permettant ainsi de réaliser des finitions multimatérielles spectaculaires, avec d'excellentes performances acoustiques aux fréquences de conversation. Petra habille avec style les environnements modernes, où la matière est au centre du projet. L'aspect rugueux souligne l'authenticité du revêtement.

## SCHEDA TECNICA

Pannello MDF sp. 16 mm rivestito con ardesia. Su richiesta pannelli in mdf ignifugo classe 1 secondo normativa CE classe 1 di reazione al fuoco (B, s2, d0)

## DATA SHEET

16 mm thick MDF panel lined with 2 mm thick concrete on visible side. Upon request, fireproof MDF panels class 1 according to EC Regulation, reaction to fire (B, s2, d0)

## FICHE TECHNIQUE

Panneau MDF ép. 16 mm revêtu de ciment sur le côté apparent, ép. 2 mm. Sur demande, panneaux en MDF ignifuge classe 1 selon la réglementation CE classe 1 de réaction au feu (B, s2, d0)

## SISTEMA DI AGGANCIO

BRICK SYSTEM a parete. SILHOUETTE a soffitto.

## MOUNTING SYSTEM

Wall BRICK SYSTEM. Ceiling SILHOUETTE.

## SYSTÈME DE FIXATION

BRICK SYSTEM au mur. SILHOUETTE au plafond.

# DECORVOX

PANNELLI IN FELTRO  
DI LANA FONDOASSORBENTE

WOOL FELT  
SOUND-ABSORBING PANELS

PANNEAUX EN FEUTRE  
DE LAINE INSONORISANT



Decorvox è composto all'80% da lana naturale.

Decorvox is made from 80% natural wool.

Decorvox se compose à 80% de laine naturelle.



## > DECORVOX

### IL CALORE DELLA LANA

Decorvox sfrutta la semplicità e l'efficienza del feltro, un materiale antico che è diventato protagonista del design più moderno, grazie alla naturalezza delle fibre della lana e a un processo di produzione affinato nei secoli. Compressione meccanica, vapore e calore: tre elementi grazie ai quali si ottengono varietà di feltro di diversa densità e spessore, che si adattano ad ogni esigenza e dimostrano sempre una grande capacità di assorbimento, grazie alla struttura porosa e alla fibra cava della lana che agisce come condotta capillare.

Le minime differenze di colore e le piccole inclusioni di fibre naturali in superficie sono la prova della naturalezza del materiale.

### THE WARMTH OF WOOL

Decorvox leverages the simplicity and efficiency of felt, an ancient material now widely used by modern designers, through its natural wool fibres and a manufacturing process that has become increasingly sophisticated over the centuries.

Mechanical compression, steam and heat: these three elements are used to obtain various types of felt with different density and thickness, suitable for every need and featuring a great sound absorption capacity due to the porous structure and the hollow fibres of wool, which acts as a capillary conduit.

Minor differences in colour and small inclusions of natural fibre on the surface prove that the material is 100% natural.

### LA CHALEUR DE LA LAINE

Decorvox exploite la simplicité et l'efficacité du feutre, un matériau ancien qui est devenu le protagoniste du design le plus moderne, grâce aux propriétés naturelles des fibres de la laine et à un processus de production affiné au cours des siècles. Compression mécanique, vapeur et chaleur : trois éléments permettant d'obtenir des variétés de feutre de différente densité et épaisseur, qui s'adaptent à toutes les exigences et démontrent toujours une grande capacité d'absorption grâce à la structure poreuse et à la fibre creuse de la laine qui agit comme un conduit très fin. Les petites différences de couleur et les petites inclusions de fibres naturelles en surface sont la preuve de l'origine naturelle du matériau.

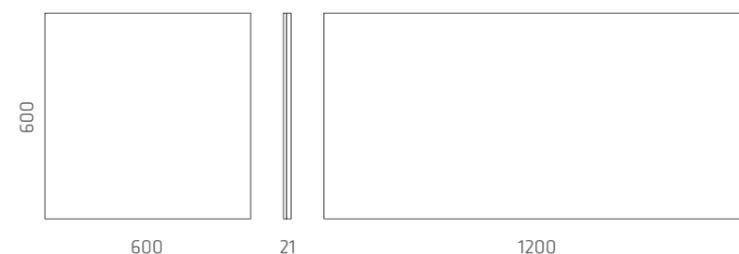

#### Dimensioni / Size / Dimensions:

600 x 600 x 21 mm  
1200 x 600 x 21 mm

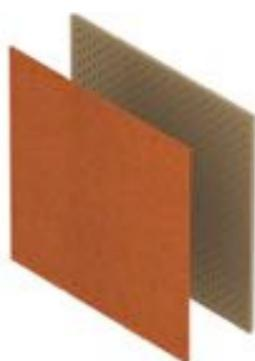

### DOVE E COME

Perfetto negli ambienti più raffinati e classici, ma anche per esaltare con una cornice di eleganza arredamenti e tecnologie hi-tech.

Versatile nell'installazione, consente l'applicazione sia in parete sia a controsoffitto, dando libertà di forme davvero uniche per questo tipo di prodotto.

### WHERE AND HOW

Perfect for the most refined and classic environments, but also to enhance furnishings and hi-tech devices with an elegant frame.

Designed to ensure high installation versatility, it can be applied on either walls and false ceilings, creating a wide variety of unique shapes for this type of product.

### OÙ ET COMMENT

Parfait dans les espaces les plus raffinés et classiques mais aussi pour exalter les ameublements et les technologies hi-tech avec un contexte d'élégance. Caractérisé par une installation polyvalente, il peut être appliqué au mur ou au faux plafond, et permet de composer librement des formes vraiment uniques pour ce type de produit.

### CAMPIONE SOTTOPOSTO A PROVA

Pannello in MDF + Feltro 5 mm mod. DECORVOX con intercapedine h.260 mm. con pannelli in fibra di poliestere densità 40/Kg/m3 spessore 20 mm.

### SAMPLE TESTED

MDF Panel + 5 mm Felt mod. DECORVOX with air space h. 260 mm polyester fibre panels density 40 Kg/m3 thickness 20 mm.

### ÉCHANTILLON SOUMIS À ESSAIS

Panneau en MDF + Feutre 5 mm mod. DECORVOX avec double paroi h. 260 mm. avec panneaux en fibre de polyester densité 40 kg/m3 20 mm d'épaisseur.



### SCHEDA TECNICA

Pannello MDF sp. 16 mm ignifugo, forato Ø 10, passo 16 mm passante, e accoppiato con feltro misto lana sp. 5 mm sul lato a vista.

- Composizione 80% lana 20% viscosa.
- Densità 0,30 gr/cm3,
- Peso 1500 g/m2
- Resistenza alla temperatura: a 100°C irruvidisce, a 130°C inizia a decomporsi
- trattamento ignifugazione AP 171 Categoria 1 (UNI 8456/8457).
- classe 1 (B,s2; d0).

**SISTEMA DI AGGANCIO**  
VARIOFIX BRICKWALL a parete.

**QUANTITÀ MINIMA**  
18 mq.

### DATA SHEET

16 mm fireproof MDF panel, perforated, hole Ø 10, 16 mm pitch, coupled with 5mm thick mixed wool felt on the visible side.

- Composition 80% wool 20% viscosa.
- Density 0.30 gr/cm3,
- Counterweight 1500 g/m2
- Resistance to temperature: roughens at 100°C, decomposition begins at 130°C
- AP 171 fireproofing treatment Category 1 (UNI 8456/8457).
- class 1 (B,s2; d0).

**MOUNTING SYSTEM**  
Wall VARIOFIX BRICKWALL.

**MINIMUM QUANTITY**  
18 sqm.

### FICHE TECHNIQUE

Panneau MDF ép. 16 mm ignifuge, perforé Ø 10, pas passant 16 mm, et accouplé avec du feutre mixte laine ép. 5 mm du côté apparent.

- Composition 80% laine 20% viscosa.
- Densité 0,30 g/cm3,
- Poids 1500 g/m2
- Résistance à la température : à 100 °C il devient rugueux, à 130 °C il commence à se décomposer
- traitement d'ignifugation AP 171 Catégorie 1 (UNI 8456/8457).
- classe 1 (B, s2 ; d0).

**SYSTÈME DE FIXATION**  
VARIOFIX BRICKWALL au mur.

**QUANTITÉ MINIMUM**  
18 m2.

### CARTELLA COLORI COLOUR CHART PALETTE DE COULEURS



# METALIA

PANNELLI DI LAMIERA  
CON FORI TRIDIMENSIONALI

STEEL PLATE PANELS WITH  
THREE-DIMENSIONAL HOLES

PANNEAUX EN TÔLE AVEC  
PERFORATIONS TRIDIMENSIONNELS



Metalia è in lamiera in acciaio, acciaio inox, alluminio, rame.

Metalia is made of sheet steel, stainless steel, aluminium, copper.

Metalia est composé de tôle d'acier, d'acier inoxydable, d'aluminium et de cuivre.



# > METALIA

## L'IMMAGINE ATTRAVERSA IL METALLO

Un retino di fori di dimensione variabile su pannelli di metallo, per riprodurre immagini figurative o astratte: Metalia. La tecnologia Raster Punch® rende eterne le rappresentazioni lasciate filtrare da giochi di luce semplici ed eleganti allo stesso tempo, per emozioni visive originali amplificate dal benessere acustico. I materiali fonoassorbenti lavorano segretamente oltre la superficie, mentre il sistema di retroilluminazione accende l'ambiente per affascinare con discrezione.

## IMAGES ACROSS THE METAL

Perforated metal panels with holes of varying sizes to reproduce figurative or abstract images: this is Metalia. The Raster Punch® technology creates timeless images filtered through a simple yet elegant interplay of light, for unique visual emotions enhanced by acoustic comfort. Sound-absorbing materials secretly play their role below the surface, while a backlighting system lights up the room with a subtle charm.

## L'IMAGE TRAVERSE LE MÉTAL

Un réseau de perforations de dimension variable sur des panneaux en métal, pour reproduire des images figuratives ou abstraites: Metalia. La technologie Raster Punch® rend éternelles les représentations filtrées grâce à des jeux de lumière, simples et élégants à la fois, en mesure de susciter des émotions visuelles originales amplifiées par le bien-être acoustique. Les matériaux insonorisants travaillent secrètement au-delà de la surface alors que le système de rétroéclairage illumine l'espace pour fasciner avec discrétion.

### Dimensioni / Size / Dimensions:

600 x 600 x 16-18-21 mm  
1200 x 600 x 16-18-21 mm  
1000 x 2500 x 16-18-21 mm

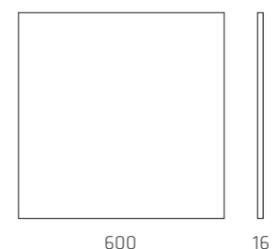

Esempio di personalizzazione con luce integrata / Customisation example with built-in light / Exemple de personnalisation avec éclairage intégré.

### DOVE E COME

Un sistema moderno e carismatico per trasformare esercizi pubblici, abitazioni, sale polivalenti in ambienti comodi all'orecchio e belli alla vista. Una finestra sul wellness.

### WHERE AND HOW

A modern, attractive system to turn public buildings, homes or multi-purpose rooms into spaces that are pleasing to the ear and beautiful to the eye. A window that gives onto comfort and wellness.

### OÙ ET COMMENT

Un système moderne et charismatique pour transformer des établissements publics, logements, salles polyvalentes en des espaces confortables à l'ouïe et beaux à la vue. Une fenêtre sur le bien-être.

## CAMPIONE SOTTOPOSTO A PROVA

Pannello in lamiera acciaio con forature diametro 5 mm. Passo 8 mm, montaggio in aderenza con pannelli in fibra di poliestere densità 40/Kg/m3 spessore 20 mm.

## SAMPLE TESTED

Sheet steel panel with holes measuring 5 mm in diameter. 8 mm pitch, flush mounted with polyester fibre panels, density 40/Kg/m3, thickness 20 mm.

## ÉCHANTILLON SOUMIS À ESSAIS

Panneau en tôle d'acier percé de perforations de 5 mm de diamètre. Pas 8 mm, montage adhérent avec des panneaux en fibre de polyester, densité 40 kg/m3, épaisseur 20 mm.

frequenza (Hz) > frequency (Hz) > fréquence (Hz) >

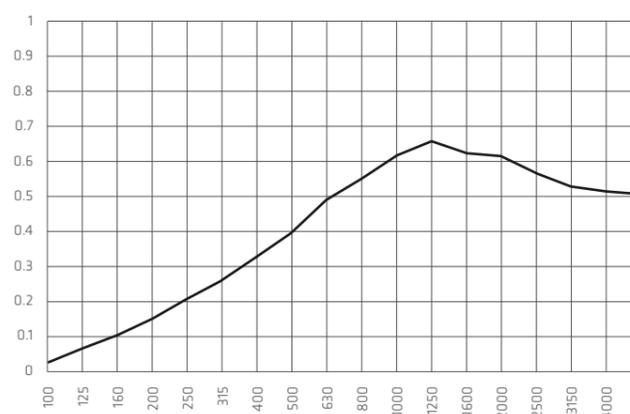

coefficiente di assorbimento acustico (alpha) >  
sound absorption coefficient (alpha) >  
coefficient d'absorption acoustique (alpha) >



Esempio di personalizzazione / Customisation example / Exemple de personnalisation.

### Colori standard:

Verniciatura epossidica colori RAL.  
Su richiesta:  
Acciaio inox, Alluminio satinato, Rame

### Standard colours:

RAL colour epoxy paints.  
On request:  
Stainless steel, satin finish Aluminium, Copper

### Couleurs standard :

Peinture époxydique, couleurs RAL.  
Sur demande :  
Acier inoxydable, Aluminium satiné, Cuivre.

### SCHEDA TECNICA

Pannellatura in lamiera verniciata, materassino posteriore in fibra di poliestere sp. 20 mm, integrabile con i prodotti (Listen, Concretech, Decovox) variando gli spessori della pannellatura.

### DATA SHEET

Painted sheet panels, 20 mm-thick rear polyester fiber pad; it can be integrated with other products (Listen, Concretech, Decovox) by changing panel thickness.

### FICHE TECHNIQUE

Panneau en tôle peinte, matelas arrière en fibre de polyester ép. 20 mm, pouvant être combiné avec les produits (Listen, Concretech, Decovox) en modifiant les épaisseurs du panneau.

- Punzonatura con sistema brevettato RASTERPUNCH con tipologie e disegni a richiesta.
- Densità 40 Kg/mc.

- Punched with patented system RASTERPUNCH with customised patterns and drawings upon request.
- Density 40 Kg/m3

- Poinçonnage avec système breveté RASTERPUNCH avec types et dessins sur demande.
- Densité 40 kg/m3.

### SISTEMA DI AGGANCIO

M32 a parete.

### MOUNTING SYSTEM

Wall M32.

### SYSTÈME DE FIXATION

M32 au mur.

**PRR** design: Sandro Rai

STRUTTURA MODULARE CON ELEMENTI  
ORIENTABILI FONDOASSORBENTI  
RIVESTITI IN TESSUTO ELASTICIZZATO

MODULAR STRUCTURE WITH ADJUSTABLE  
SOUND-ABSORBING ELEMENTS COVERED  
WITH STRETCH FABRIC

STRUCTURE MODULAIRE AVEC ÉLÉMENTS  
PHONOABSORBANTS ORIENTABLES AVEC  
REVÊTEMENT EN TISSU ÉLASTIQUE



PRA' è orientabile su più assi, in modo da poter creare delle superfici irregolari per una migliore prestazione fonoassorbente.

PRA' can be adjusted along multiple axes, so as to create irregular surfaces for improved sound-absorbing performance levels.

PRA' est orientable sur plusieurs axes, de manière à pouvoir créer des surfaces irrégulières pour de meilleures prestations d'absorption phonique.

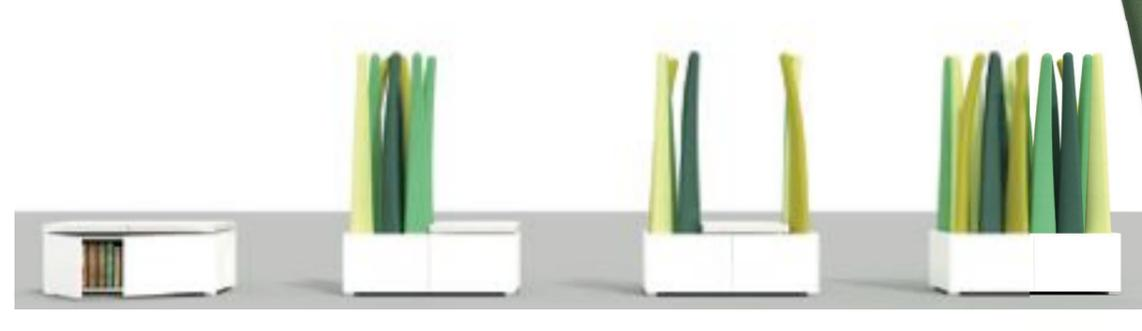

# > PRA'

## FONOASSORBENZA VERDE

Forme e geometrie appositamente studiate per migliorare il comfort acustico dell'ambiente che ti circonda. I fili d'erba fanno di PRA' un oggetto dall'alto potere fonoassorbente con ottime prestazioni acustiche in ambienti open space. PRA' è studiato per la massima modularità ed è componibile secondo esigenze e desideri. Porta divertimento all'interno dei tuoi spazi, e migliora il tuo benessere acustico.

## GREEN SOUND ABSORPTION

Dedicated shapes and purpose-designed geometries to improve acoustic comfort in your surroundings. Blades of grass make PRA' a product with superior sound-absorbing properties and excellent acoustic performance levels in open-plan settings. PRA' is designed to be totally modular and the different elements can be combined according to needs and desires. It brings fun to your interiors, while improving your acoustic comfort.

## ABSORPTION PHONIQUE VERTE

Formes et géométrie étudiées spécifiquement pour améliorer le confort acoustique de l'environnement qui vous entoure. Les brins d'herbe font de PRA' un élément au pouvoir d'absorption phonique élevé, avec des prestations acoustiques optimales pour les environnements ouverts. PRA' est étudié pour permettre une modularité maximale et une adaptabilité en fonction de vos exigences et volontés. Il intègre un aspect divertissant dans vos espaces et améliore votre bien-être acoustique.

### Moduli / Moduli / Moduli:

cod.PR9N foglie / leaves / feuilles  
cod.PR9M mobile / cabinet / meuble  
cod.PR9Z cuscino / cushion / coussin

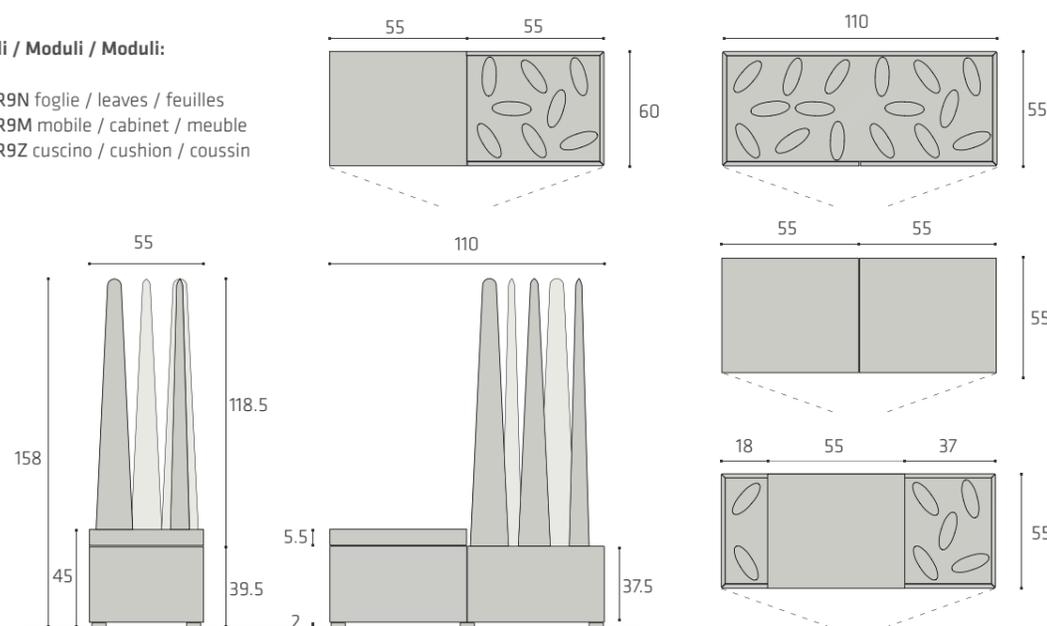

### DOVE E COME

Componi il tuo spazio: modula PRA' secondo le tue esigenze e ottieni incredibili risultati fonoassorbenti. Perfetto in uffici open space, scuole, hall, abitazioni. Non ha limiti nelle sue applicazioni.

### WHERE AND HOW

Configure your space: modulate PRA' according to your own requirements to achieve incredible sound-absorbing results. Perfect for open-plan offices, schools, halls and homes. There are no limits to its applications.

### OÙ ET COMMENT

Modelez vos espaces : agencez PRA' selon vos exigences et volontés pour obtenir une absorption phonique supérieure à vos attentes. Idéal pour les bureaux en open space, les écoles, les halls et les habitations. Ses possibilités d'utilisation sont sans limites.

Confronto del tempo di riverbero nella camera riverberante (7,70x5,60x3,70 m) con e senza PRA'.

Comparison between reverberation time in reverberating chamber (7.70x5.60x3.70 m) with and without PRA'.

Comparaison du temps de réverbération dans la chambre à réverbération (7,70 x 5,60 x 3,70 m) avec et sans PRA'.

Hz	T60 con Prà (s)	T60 senza Prà (s)	Differenza (s)	% Riduzione tempi riverberazione	Area di assorbimento acustico equivalente del Prà (mq)
100	4,09	4,45	0,36	8	0,52
125	4,05	4,84	0,79	16	1,05
160	4,55	5,39	0,84	16	0,91
200	5,37	6,30	0,93	15	0,72
250	5,48	7,04	1,56	22	1,06
315	5,13	6,83	1,70	25	1,27
400	4,45	6,22	1,77	28	1,68
500	4,07	5,69	1,62	28	1,84
630	4,02	6,00	1,98	33	2,16
800	3,76	5,64	1,88	33	2,33
1000	3,24	4,79	1,55	32	2,61
1250	3,10	4,67	1,57	34	2,84
1600	3,07	4,82	1,75	36	3,12
2000	2,90	4,52	1,62	36	3,24
2500	2,60	3,93	1,32	34	3,40
3150	2,23	3,24	1,01	31	3,65
4000	1,84	2,48	0,63	26	3,63
5000	1,48	1,92	0,43	23	3,99

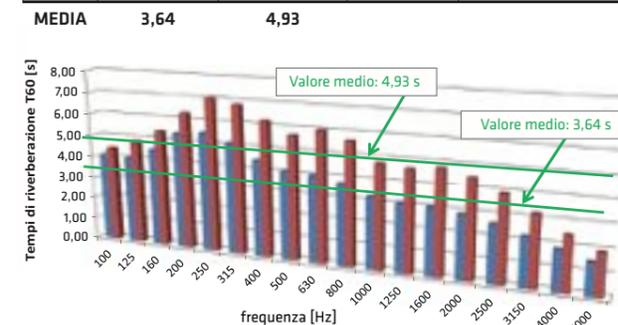

Intervallo di frequenza 100 Hz - 3.15 kHz. Scala cromatica di intensità acustica da 81 dB(A) - 85 dB(A).

Frequency range 100 Hz - 3.15 kHz. Chromatic scale of acoustic intensity from 81 dB(A) - 85 dB(A).

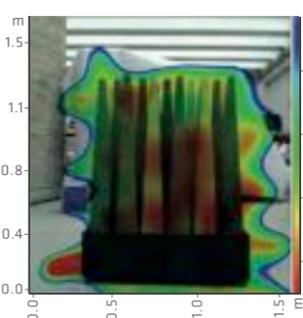

Intervalle de fréquence 100 Hz - 3,15 kHz. Échelle chromatique d'intensité acoustique de 81 dB(A) - 85 dB(A).

### STRUTTURA /STRUCTURE/ STRUCTURE

Pannello nobilitato con finitura melaminica e bordi ABS sp. 1 mm  
Melamine-surfaced panel with ABS edges, 1 mm thick  
Panneau avec revêtement et finition mélaminée et bords ABS de 1 mm d'épaisseur.



WHITE

### CARTELLA COLORI / COLOUR CHART / PALETTE DE COULEURS

#### FOGLIE/ LEAVES / FEUILLES



T80

T81

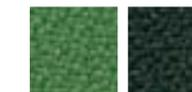

T82

T83

**CUSCINO** in struttura lignea rivestita e imbottita. Tessuto secondo cartella colori Ares Line.

**CUSHION** in padded and covered wood structure. Fabric according to Ares Line colour chart.

**COUSSIN** à structure linéaire avec revêtement et rembourrage. Fabric according to Ares Line colour chart.

### SCHEDA TECNICA

- Riduzione media superiore del 33% sulle frequenze del parlato ( tra i 500 HZ ed i 2000 HZ ).
- Parti morbide e cuscini realizzate con materiali ignifughi Classe 1

### TECHNICAL DATA SHEET

- Average reduction of more than 33% on voice frequencies (between 500 HZ and 2000 HZ).
- Soft parts and cushions made with Class 1 flame-retardant materials

### FICHE TECHNIQUE

- Réduction moyenne supérieure de 33 % sur les fréquences de conversation (entre 500 et 2 000 Hz).
- Parties douces et coussins composés de matériaux ignifuges de classe 1.



# MOSSwall® Acoustic

PANNELLO MODULARE MOSSWALL®  
E FIBRA DI POLIESTERE.

MODULAR MOSSWALL®  
AND POLYESTER FIBRE PANEL.

PANNEAU MODULAIRE MOSSWALL®  
ET FIBRE DE POLYESTER.



Mosswall® Acoustic è composto da pannelli Mosswall® in lichene naturale stabilizzato e fibra di poliestere.

Mosswall® Acoustic consists of Mosswall® panels in stabilised natural lichen and polyester fibre.

Mosswall® Acoustic est composé de panneaux Mosswall® en lichen naturel stabilisé et en fibre de polyester.

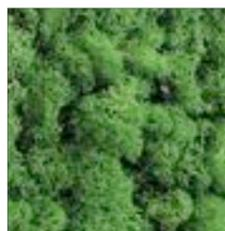

# > MOSSwall® Acoustic

## LA SUPERFICIE GREEN DELL'ACUSTICA

La collaborazione con Verde Profilo®, azienda che ha inventato e brevettato MOSSwall®, ha portato all'evoluzione acustica del prodotto. Composto dal pannello MOSSwall® standard, con sottostruttura MOSSwall® e pannello in fibra di poliestere, unisce design e comfort acustico.

## THE GREEN ACOUSTIC SURFACE

The partnership with Verde Profilo®, the company that invented and patented MOSSwall®, has led to the acoustic evolution of the product. Consisting of the standard MOSSwall® panel, MOSSwall® substructure and polyester fibre panel, it teams design with acoustic comfort.

## LE CÔTÉ NATUREL DE L'ACOUSTIQUE

La collaborazione avec Verde Profilo®, entreprise créatrice de l'invention brevetée MOSSwall®, a abouti à l'évolution acoustique du produit. Le panneau MOSSwall® standard, associé à la sous-structure MOSSwall® et aux panneaux en fibre de polyester, réunit design et confort acoustique.

**Dimensioni del singolo pannello / Individual panel dimensions / Dimensions d'un panneau / Rettangolare / Rectangular / Rectangulaire**  
600 x 400 x 40 mm

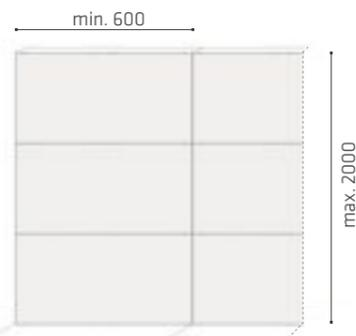
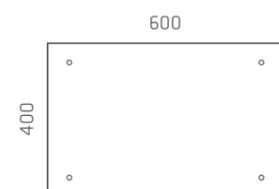

parete autoportante /stand alone wall / mur autoportant



doppio modulo 1200x1200mm / double module 1200 x 1200 mm / double module 1 200 x 1 200 mm

## DOVE E COME

MOSSwall® Acoustic è un prodotto altamente performante e versatile. I molteplici sistemi di applicazione consentono di realizzare rivestimenti murali, pareti autoportanti e pareti divisorie.

## WHERE AND HOW

MOSSwall® Acoustic is a versatile, high-performing product. The multiple application systems enable the creation of wall coverings, stand alone walls and partition walls.

## OÙ ET COMMENT

MOSSwall® Acoustic est un produit hautement performant et polyvalent. Sa polyvalence permet de réaliser des revêtements muraux, des plafonds autoportants et des murs de division.

## SCHEDA TECNICA

Pannello modulare in lamiera zincata dimensioni 400x600 mm rivestito in MOSSwall® e pannelli in fibra di poliestere.

## TECHNICAL DATA SHEET

Modular galvanised sheet metal panel measuring 400x600 mm covered with MOSSwall® and polyester fibre panels.

## FICHE TECHNIQUE

Panneau modulaire en tôle zinguée, dimensions 400 x 600 mm avec revêtement MOSSwall® et panneaux en fibre de polyester.

## SISTEMA DI MONTAGGIO

Parete a muro, parete a spinta, parete autoportante.

## MOUNTING SYSTEMS

Wall against outside wall, room divider wall, stand alone wall.

## SYSTÈME DE MONTAGE

Paroi murale, paroi en poussée, paroi autoportante.

## CAMPIONE SOTTOPOSTO A PROVA

Pannello 3000 x 3600 mm  
Installazione distanziata di 30mm.

## SAMPLE TESTED

3000 x 3600 mm panel  
Installation spacing 30 mm.

## ÉCHANTILLON SOUMIS À ESSAIS

Panneau 3000 x 3600 mm  
Installation espacée de 30 mm.

frequenza (Hz) > frequency (Hz) > fréquence (Hz) >

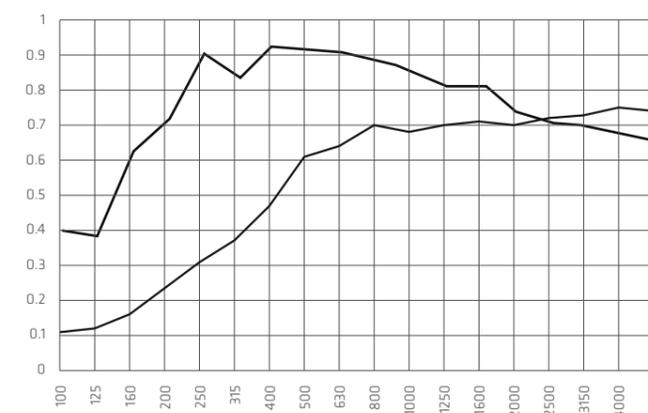

coefficiente di assorbimento acustico (α)  
sound absorption coefficient (α)  
coefficient d'absorption acoustique (α)

## SCHEDA TECNICA

- Coefficiente di assorbimento acustico:  $\alpha_w=0.55$  (installazione distanziata 30mm da soffitto/parete)
- Prodotto antistatico e antibatterico

Per ordinativi inferiori ai 40 mq verificare sul listino le combinazioni di colori disponibili.

## DATA SHEET

- Acoustic absorption coefficient:  $\alpha_w=0.55$  (installation spaced 30 mm from the ceiling/wall)
- Antistatic and anti-bacterial product

For orders below 40 square metres check the colour combinations available on the price list.

## FICHE TECHNIQUE

- Coefficient d'absorption acoustique :  $\alpha_w = 0,55$  (installation espacée de 30 mm du plafond/mur)
- Produit antistatique et antibactérien

Pour les commandes de moins de 40 m<sup>2</sup>, vérifier les combinaisons de couleurs disponibles dans le catalogue.



fatto a mano  
hand-made  
fait main



prodotto in Italia  
made in Italy  
produit en Italie



brevettato  
patented  
breveté



garantito 4 anni  
4-year guarantee  
garanti 4 ans



acustico  
acoustic  
acoustique



antistatico  
antistatic  
antistatique



naturale 100%  
100% natural  
100 % naturel



non da esterno  
not for outdoor use  
usage intérieur



non annaffiare  
do not water  
ne pas arroser



no esposizione luce diretta  
no direct exposure  
pas d'exposition directe



non cresce  
does not grow  
ne pas couper



antibatterico  
anti-bacterial  
antibactérien



tasso umidità richiesto  
humidity rate  
taux d'humidité requis

## COLORI / COLOURS / COULEURS

### OCEAN

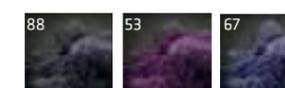
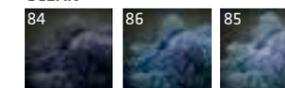

### FOREST



### DESERT

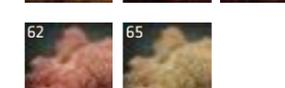

### NEUTRAL



con maggiorazione /at extra charge / avec majoration

### FUSION



## FINITURE / FINISHES / FINITIONS





# MASTERPIECE

L'ARTE INCONTRA FONOLGY  
E LE OPERE DIVENTANO  
FONOASSORBENTI

ART MEETS FONOLGY AND  
ARTWORKS BECOME  
SOUND-ABSORBING

L'ART RENCONTRE FONOLGY ET  
L'ABSORPTION PHONIQUE



# Fonology meets art

Accostiamo alla multimatericità l'approccio multidisciplinare, fonte di innovazione e ispirazione. Così Fonology incontra il mondo dell'arte in un laboratorio artistico di Fossombrone, dove due appassionate artiste di grande esperienza hanno abbracciato il progetto "Fonology meets art". Anche loro, come noi, credono nel valore aggiunto di un'opera d'arte capace di migliorare acusticamente il tuo ambiente, come dimostrato da test di laboratorio.

We combine multi-material availability with a multi-disciplinary approach, a source of innovation and inspiration. Thus Fonology meets up with the art world in an art laboratory in Fossombrone, where two passionate artists with plenty of experience embraced the project entitled "Fonology meets art". They too, like us, believed in the added value of a work of art capable of improving your environment acoustically, as demonstrated by laboratory tests.

Nous associons au multimatiérisme une approche multidisciplinaire, source d'innovation et d'inspiration. Ainsi, Fonology rencontre le monde de l'art dans un laboratoire artistique de Fossombrone (Italie), où deux artistes expérimentées et passionnées ont accueilli le projet « Fonology meets art » (Fonology rencontre l'art). Elles aussi, comme nous, ont cru en la valeur ajoutée d'une œuvre d'art capable d'améliorer l'acoustique de votre environnement, comme les essais en laboratoire le prouvent.



"Dopo un'esperienza ventennale presso un'importante studio artistico italiano, nel 2006 nasce Alema 1.0 come studio di restauro d'arte contemporanea, studio artistico, progettazione e realizzazione di oggetti d'arredo e di design. Abbiamo eseguito importanti restauri su opere d'arte contemporanea, della collezione Maramotti, Sonnabend, ecc.. La curiosità e la ricerca riguardo svariati materiali quali vegetali, lamina di piombo, stagno, legno, ferro, sale, tabacco, muschio, hanno portato ad ampliarne l'utilizzo standard trasformandoli in opere d'arte uniche nel loro genere e interamente eseguite a mano."

Alessandra ed Emanuela | Alema1.0

"After twenty years' experience in a leading Italian art studio, Alema 1.0 was set up in 2006 as a studio for the restoration of contemporary art works, an art studio, designing and producing items of interior décor and design. We have completed some major restoration work on contemporary art works, from the Maramotti collection, Sonnabend, etc.. Curiosity and research into various materials, including plants, lead lamina, tin, wood, iron, salt, tobacco and moss have led us to extend their standard use and transform them into unique, one-of-a-kind works of art that are entirely hand-crafted."

Alessandra ed Emanuela | Alema1.0

"Après 20 ans de pratique auprès d'un important studio artistique italien, le studio Alema 1.0 est créé en 2006. Il exerce la restauration d'art contemporain, accueille un studio artistique et gère la conception et la réalisation d'objets de mobilier et de design. Nous avons procédé à des restaurations d'envergure sur des œuvres d'art contemporaines, des collections Maramotti, Sonnabend, etc. Notre curiosité et notre recherche sur de nombreux matériaux tels que des végétaux, plaques de plomb, l'étain, le bois, le fer, le sel, le tabac ou encore le musc nous ont conduites à en développer l'utilisation en les transformant en œuvres d'art uniques en leur genre et intégralement réalisées à la main."

Alessandra ed Emanuela | Alema1.0



## WALNUTS ENSEMBLE

Supporto in lamiera di acciaio, foglie di noce stabilizzate con metodo naturale. Bordo in lamina di piombo. Sheet steel support, walnut leaves stabilised using a natural method. Lead lamina edge. Support en tôle d'acier, feuilles de noyer stabilisées par un processus naturel. Bord en tôle de plomb. 1200 x 600 x 50 mm



## NON-OBJECTIVE COMPOSITION DI LIUBOV POPOVA

Lamina di piombo, sassi e legni combusti. Lead lamina, pebbles and burned wood. Tôle de plomb, pierre et bois brûlé. 1200 x 1600 x 40 mm



## TRITTICO

Composizione di sassi, trucioli di alluminio e piombo su lamiera forata. Bordo in lamina di piombo. Composition of pebbles, aluminium and lead shavings on perforated sheet metal. Lead lamina edge. Composition de pierre, éclats d'aluminium et de plomb sur tôle percée. Bord en tôle de plomb. 250 x 250 x 60 mm



## LE VIE DELLA LUCE

Lamiera di acciaio, piombo in lamina, legno combusto, vetro. Sheet steel, lead lamina, burned wood and glass. Tôle d'acier, plaque de plomb, bois brûlé, verre. 750 x 1320 x 80 mm



## NUDO BLU II DI MATISSE

Composizione di licheni stabilizzati colorati su lamiera forata. Bordo in lamina di piombo. Composition of coloured stabilised lichens on perforated sheet. Lead lamina edge. Composition de lichens colorés sur tôle percée. Bord en tôle de plomb. 1260 x 670 x 40 mm



## A COLORI

Composizione di lichene stabilizzato colorato su lamiera forata. Bordo in lamina di piombo. Composition of coloured stabilised lichen on perforated sheet. Lead lamina edge. Composition de lichen stabilisé coloré sur tôle percée. Bord en tôle de plomb. 600 x 1200 x 60 mm

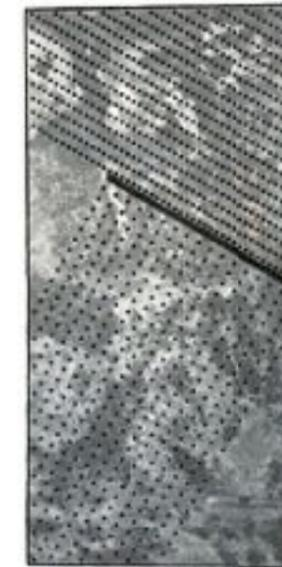

## ICELEAD

Lamiera di acciaio, piombo in lamina legno combusto. Sheet steel, lead lamina and burned wood. Tôle d'acier, plaque de plomb, bois brûlé. 1200 x 600 x 40 mm



## HEARTH DI KEITH HARING

Composizione di trucioli di alluminio, piombo e sassi. Bordo in lamina di piombo. Composition of aluminium shavings, lead, and pebbles. Lead lamina edge. Composition d'éclats d'aluminium et de plomb et pierre. Bord en plaque de plomb. 1000 x 1000 x 40 mm

dettagli, details, detalles



## WALNUTS ENSEMBLE



## NON-OBJECTIVE COMPOSITION DI LIUBOV POPOVA



## YING & YANG



## LE VIE DELLA LUCE



## A COLORI



## ICELEAD

Tutte le opere Masterpiece sono certificate acusticamente.

All the Masterpiece works are acoustically certified.

Toutes les œuvres Masterpiece ont une certification acoustique.



# > MASTERPIECE



**ICE LEAD**  
1200 x 600 x 40 mm

Pannelli fonoassorbenti in poliestere di sp. 20 mm e densità 40 kg/m<sup>3</sup>, con struttura rigida. Finitura superficiale con piombo e legno combusto.

Sound-absorbing polyester panels, 20 mm thick and with a density of 40 kg/m<sup>3</sup>, with rigid structure. Surface finish with lead and burned wood.

Panneaux phonoabsorbants en polyester de 20 mm d'épaisseur et de 40 kg/m<sup>3</sup> de densité, avec structure rigide. Finition superficielle avec plomb et bois brûlé.

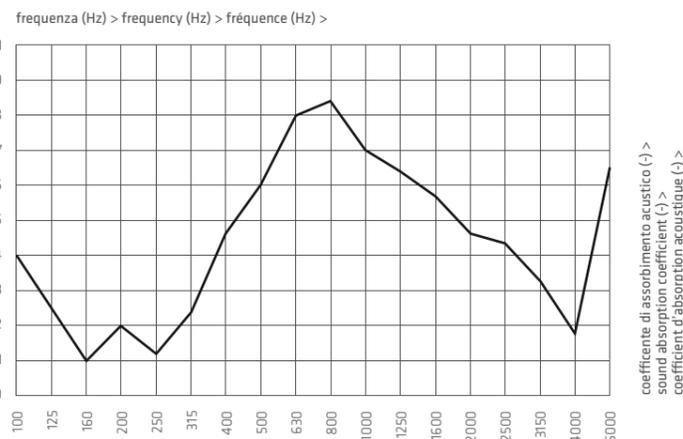

**LE VIE DELLA LUCE**  
750 x 1320 x 80 mm

Pannelli fonoassorbenti in poliestere di sp. 20 mm e densità 40 kg/m<sup>3</sup>, con struttura rigida. Finitura superficiale con piombo, vetro e legno combusto.

Sound-absorbing polyester panels, 20 mm thick and with a density of 40 kg/m<sup>3</sup>, with rigid structure. Surface finish with lead, glass and burned wood.

Panneaux phonoabsorbants en polyester de 20 mm d'épaisseur et de 40 kg/m<sup>3</sup> de densité, avec structure rigide. Finition superficielle avec plomb, verre et bois brûlé.

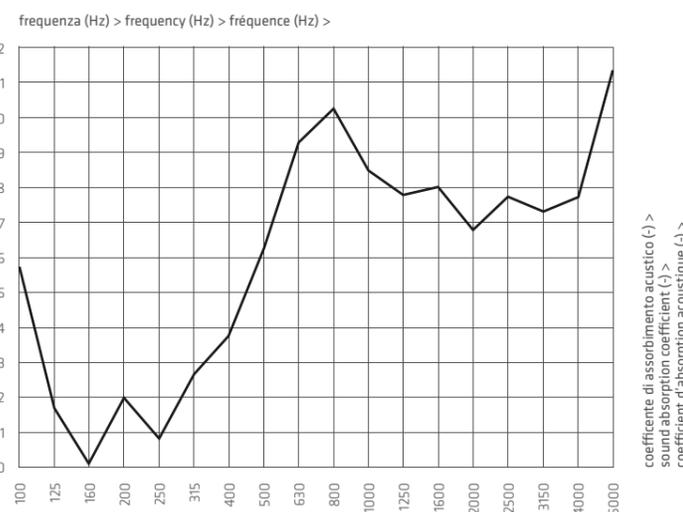

**WALNUTS ENSEMBLE**  
1200 x 600 x 40 mm



**TABACCO ENSEMBLE**  
1200 x 600 x 40 mm

Pannello fonoassorbente in poliestere di sp. 20 mm e densità 40 kg/m<sup>3</sup>, con struttura rigida. Finitura superficiale in foglie stabilizzate di tabacco e noce.

Sound-absorbing polyester panel, 20 mm thick and with a density of 40 kg/m<sup>3</sup>, with rigid structure. Surface finish in stabilised tobacco and walnut leaves.

Panneau phonoabsorbant en polyester de 20 mm d'épaisseur et de 40 kg/m<sup>3</sup> de densité, avec structure rigide. Finition superficielle en feuilles de tabac et de noyer stabilisées.

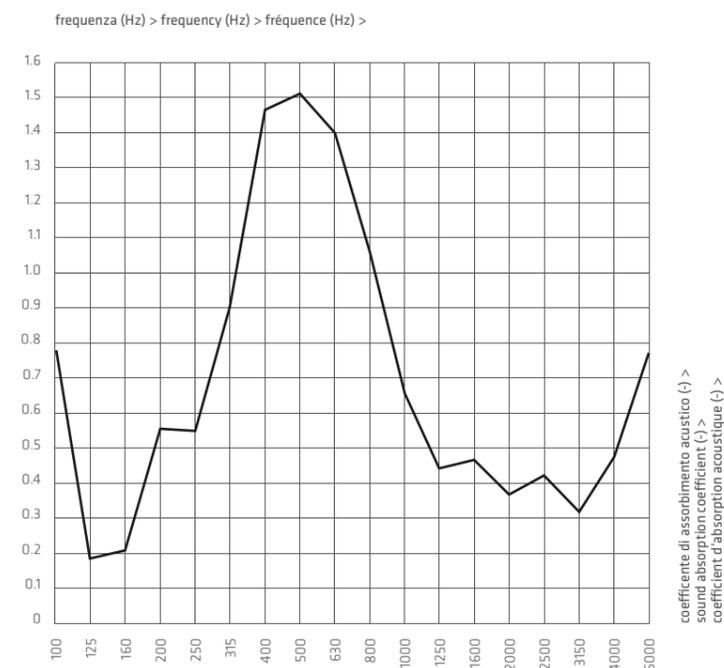

**NERO PREZIOSO**  
1200 x 600 x 40 mm



**STONESPACE**  
600 x 600 x 40 mm

**DUNES**  
singolo pannello / single panel / panneau seul  
600 x 600 x 40 mm

Pannelli fonoassorbenti in poliestere di sp. 20 mm e densità 40 kg/m<sup>3</sup>, con struttura rigida. Finitura superficiale costituita da ghiaia / sassi.

Sound-absorbing polyester panel, 20 mm thick and with a density of 40 kg/m<sup>3</sup>, with rigid structure. Surface finish comprising gravel / pebbles.

Panneau phonoabsorbant en polyester de 20 mm d'épaisseur et de 40 kg/m<sup>3</sup> de densité, avec structure rigide. Finition superficielle constituée de gravier et pierre.

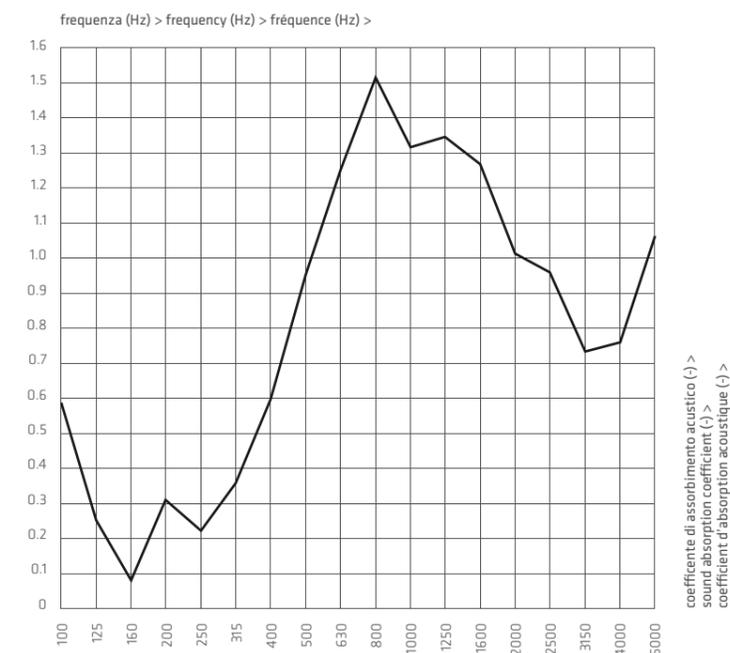



“ Al Nuovo Teatro Musicale di Linz  
l’acustica è perfetta e soprattutto  
bilanciata per quel che riguarda la  
musica e il canto.  
Sembra tutto molto naturale ”.

“ In the New Musical Theatre in  
Linz, the acoustics are perfectly  
balanced especially in regard to  
music and singing.  
It sounds very natural ”.

« Dans le nouveau Théâtre Musical  
à Linz l’acoustique est parfaite et  
équilibrée en particulier en ce qui  
concerne la musique et le chant.  
Tout semble très naturel ».

( Philip Glass )

# SISTEMI DI FISSAGGIO

## MOUNTING SYSTEMS

## SYSTÈMES DE FIXATION

Tutti i materiali Fonology sono compatibili tra loro grazie agli appositi sistemi di fissaggio, studiati per raggiungere le più svariate soluzioni componibili.

All Fonology materials are compatible with each other thanks to special mounting systems, designed to create the most diverse modular solutions.

Tous les matériaux Fonology sont compatibles entre eux grâce aux systèmes de fixation spécifiques, conçus pour permettre les solutions modulaires les plus diverses.

SISTEMA DI FISSAGGIO MOUNTING SYSTEM SYSTÈME DE FIXATION	TIPOLOGIA TYPE TIPE	AIRFORM	AIRTWIN	EASYAIR	LISTEN DOGATO	LISTEN SQUARE	CONCRETECH	PETRA	DECORVOX	METALIA	MOSSwall Acoustic®
SKY EDGE	Soffitto / Ceiling / Plafond	X	X	X	X	X	X	X	X	X	
AIRFIX	Parete - Soffitto / Wall - Ceiling / Mur - Plafond	X	X	X							
BRICK System	Parete / Wall / Mur					X	X	X			
M32	Parete / Wall / Mur									X	
SILHOUETTE	Soffitto / Ceiling / Plafond	X			X	X	X				
T15	Soffitto Semi Nascosto / Ceiling - Semi-recessed / Plafond semi encastré				X	X					
T24	Soffitto Scomparsa / Ceiling - Concealed / Plafond encastré				X	X					
T24	Soffitto Vista / Ceiling - Exposed / Plafond apparent	X			X	X					
VARIOFIX	Soffitto Scomparsa / Ceiling - Concealed / Plafond encastré				X						
VARIOFIX Curvo	Parete / Wall / Mur				X						
VARIOFIX Curvo	Soffitto / Ceiling / Plafond				X						
AGGANCIO RAPIDO®			X	X							
MOSSWALL®											X

## SKY EDGE

### ATTACCO A SOFFITTO

### CEILING MOUNT

### FIXATION AU PLAFOND

#### LIBERE COMPOSIZIONI NELL'ARIA

Sky Edge è una struttura modulare in alluminio a sospensione, si fissa a soffitto tramite sistema di cavi in acciaio ed è compatibile con qualsiasi prodotto Fonology. La struttura garantisce una estrema libertà di composizione, consentendo di mescolare i diversi pannelli per ottenere i risultati più fantasiosi ed efficaci.

#### SISTEMA DI AGGANCIAMENTO

Tramite struttura T24 (colore standard bianco) verniciabile su richiesta. Cornice laccabile RAL su richiesta.

#### VERSATILE COMPOSITIONS IN THE AIR

Sky Edge is a suspended modular aluminium structure that can be anchored to the ceiling with a steel cable system. It is compatible with all Fonology products. Its structure allows a wide choice of compositions, as different panels can be combined to obtain the most creative and effective results.

#### MOUNTING SYSTEM

T24 structure (standard white colour), painted on request. The frame can be lacquered in any RAL colour on request.

#### DES COMPOSITIONS LIBRES DANS L'AIR

Sky Edge est une structure modulaire à suspension en aluminium. On la monte au plafond au moyen d'un système de câbles en acier et elle est compatible avec n'importe quel produit Fonology. La structure garantit une liberté de composition extrême, en permettant de mélanger les différents panneaux pour obtenir des résultats ultra créatifs et efficaces.

#### SYSTÈME DE FIXATION

Au moyen de la structure T24 (couleur standard : blanc). Laquage sur demande. Cadre à laquer RAL sur demande.

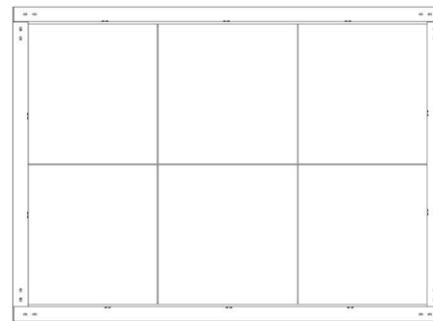
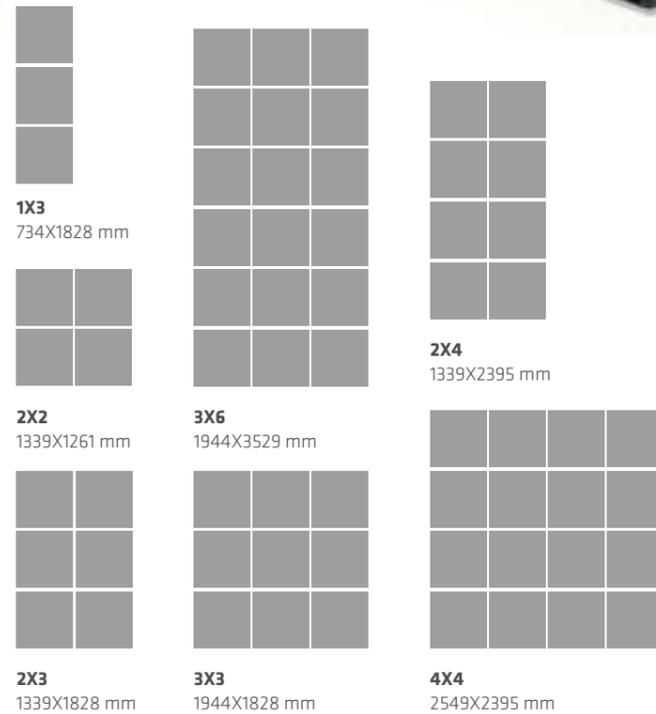

Sulla parte superiore della struttura in alluminio, sagomatura per installazione barre led (non incluse).

The aluminium structure is specifically shaped at the top for installing LED light bars (not included).

Façonnage sur le haut de la structure en aluminium, pour l'installation de barres à leds (non fournies).

## AIRFORM

### SOFFITTO T24 A VISTA E SILHOUETTE

### CEILING T24 SYSTEM

### PLAFOND T24 APPARENT

1	Tassello e vite da muro	Wall plug and screw	Cheville et vis pour mur
2	Profilo a "L" di finitura	L-shaped finishing profile	Profilé en « L » de finition
3	Tassello a soffitto con rondella	Ceiling plug with washer	Cheville au plafond avec rondelle
4	Pendino superiore	Upper hanger	Tirant supérieur
5	Farfalla di regolazione	Adjustment spring	Ressort de réglage
6	Pendino inferiore	Lower hanger	Tirant inférieur
7	Profilo T24	T24 profile	Profilé T24
8	Pannello Airform	Airform panel	Panneau Airform
9	Traverso T24	T24 crosspiece	Traverse T24

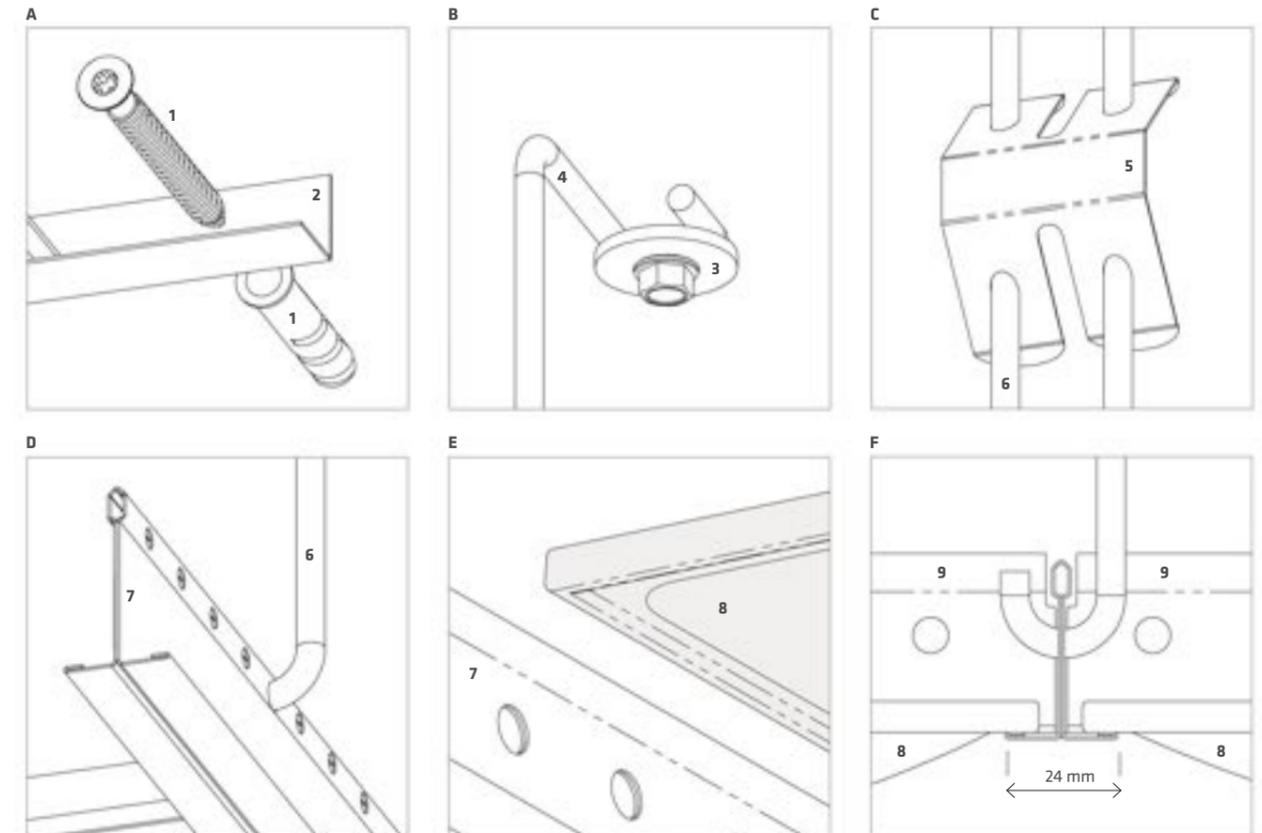
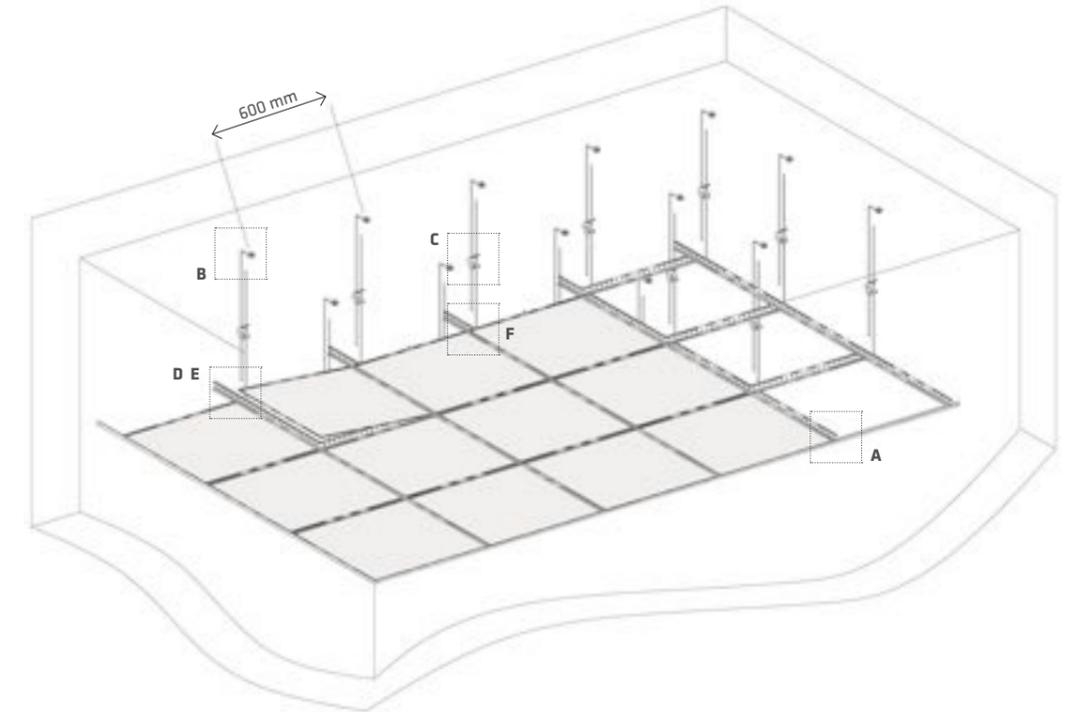

# AIRFORM

PARETE  
WALL  
MUR

1	Tassello e vite da muro	Wall plug and screw	Cheville et vis pour mur
2	Profilo a "J" di finitura	J-shaped finishing profile	Profilé en « J » de finition
3	Profilo ad Omega	Omega profile	Profilé en oméga
4	Feltro fono-assorbente	Sound-absorbing felt	Feutre insonorisant
5	Piastrina a "J" di partenza	J-shaped starting plate	Plaquette en « J » de départ
6	Vite auto-forante per fissaggio piastrine	Self-drilling screw for fixing plates	Vis autotaraudeuse pour la fixation des plaquettes
7	Piastrina "Variofix" di fissaggio	"Variofix" mounting plate	Plaquette « Variofix » de fixation
8	Doga Listen 19/2	19/2 Listen slat	Latte Listen 19/2
9	Piastrina a "J" di chiusura finale	J-shaped finishing plate	Plaquette en « J » de fermeture finale

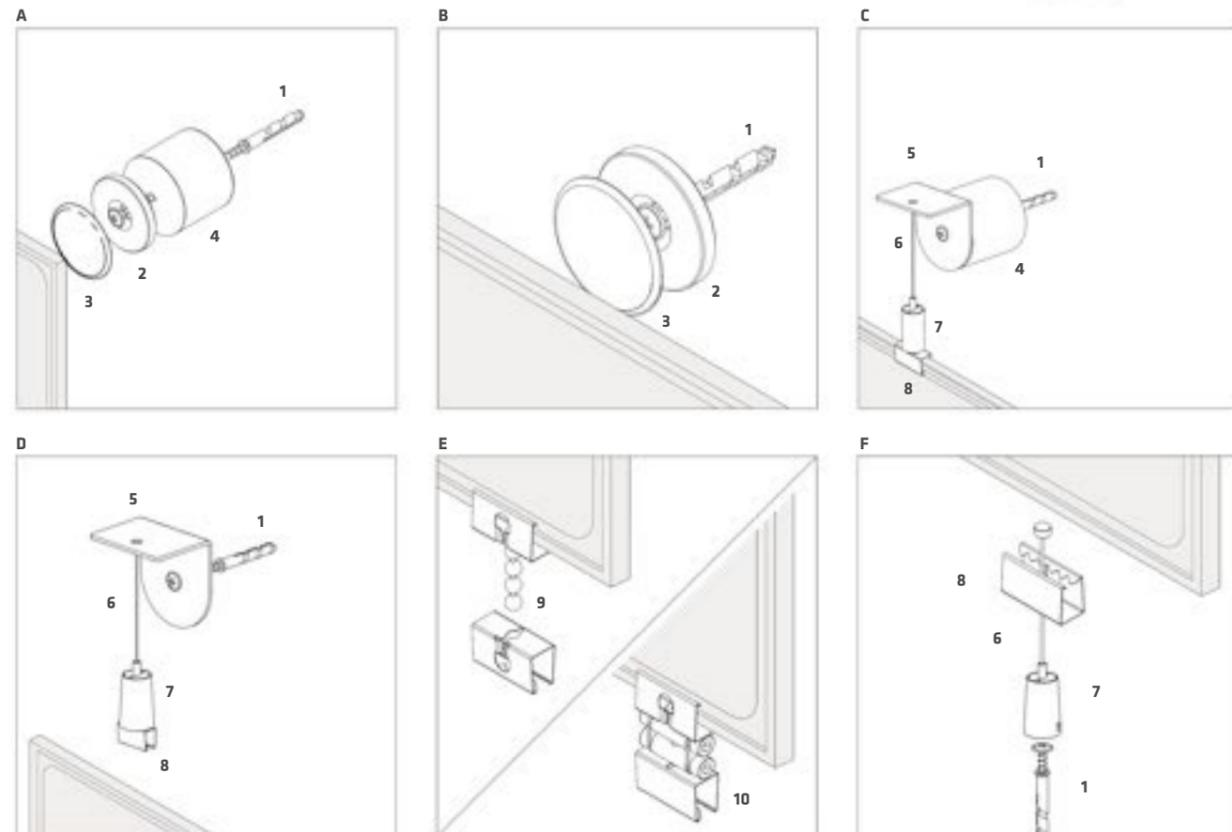
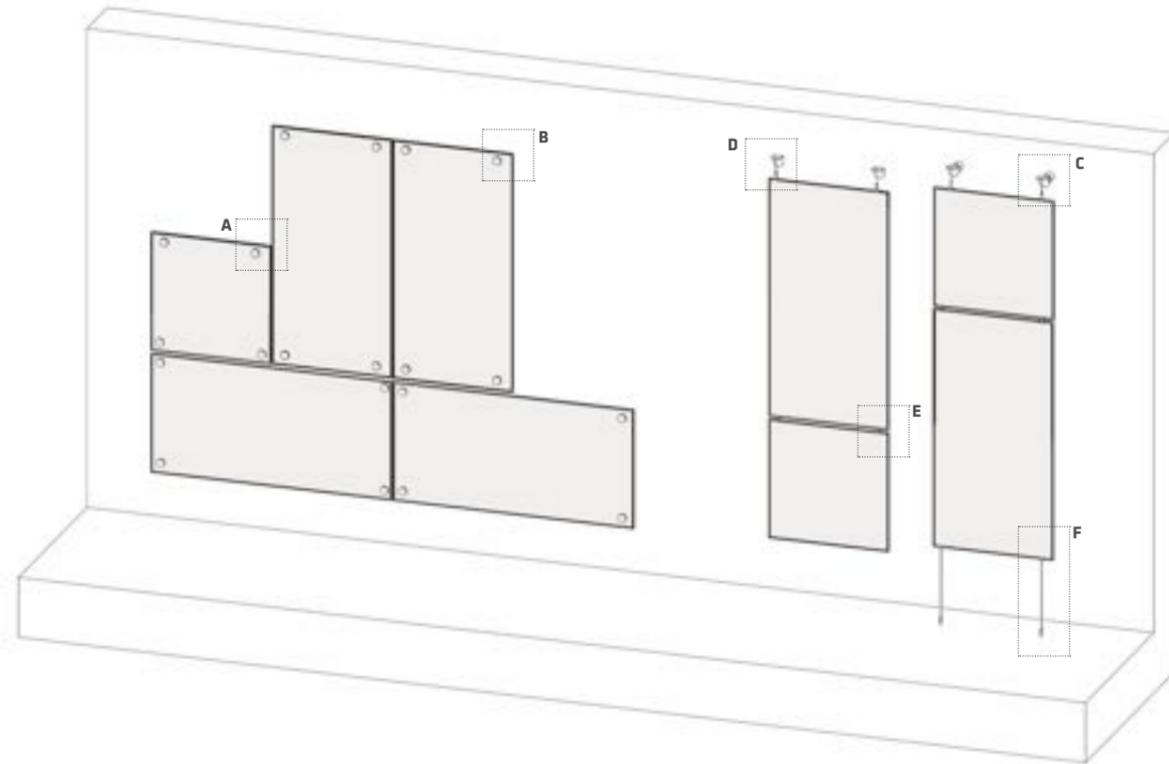

# AIRFORM AIRTWIN

ATTACCO  
A SOFFITTO

CEILING  
MOUNT

FIXATION  
AU PLAFOND

1	Tassello e vite da muro	Wall plug and screw	Cheville et vis pour mur
2	Clip di aggancio	Attachment clip	Clip de fixation
3	Cavo in acciaio	Steel cable	Câble en acier
4	Morsetto di regolazione	Adjusting clamp	Bride de réglage
5	Kit di fissaggio a soffitto con morsetto di regolazione	Ceiling mounting kit with adjusting clamp	Kit de fixation au plafond avec bride de réglage
6	Kit di collegamento clip e catena	Chain and clip connection kit	Kit de raccordement clip et chaîne
7	Kit di collegamento clip con snodo	Clip connection kit with joint	Kit de raccordement clip avec articulation
8	Zavorra	Counterweight	Poids

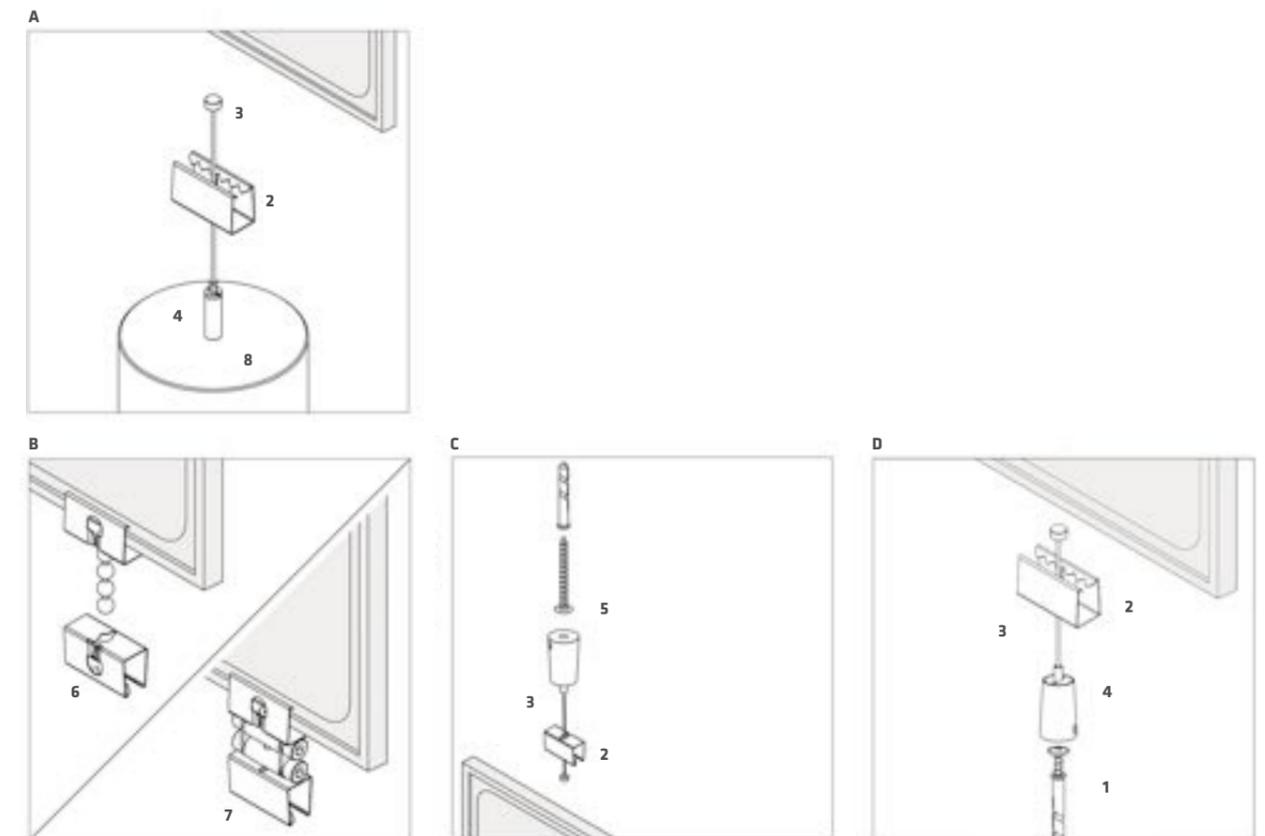
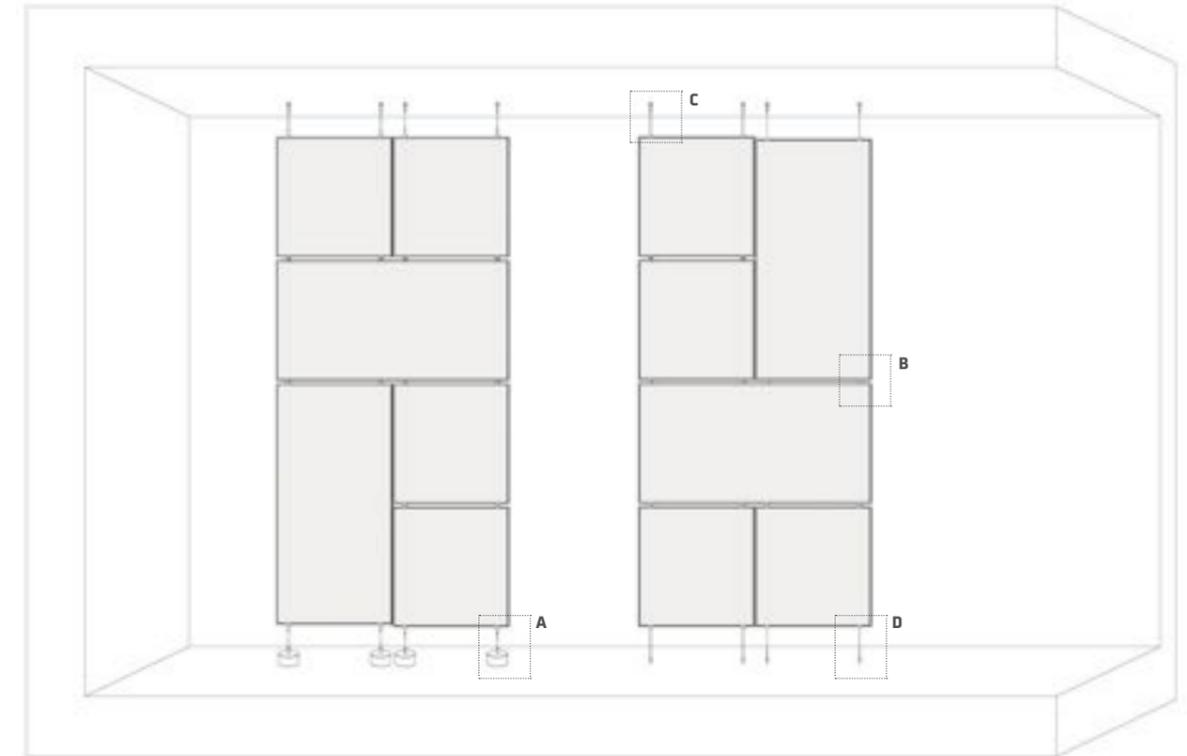

# AIRWIN

PARETE/VETRO

WALL/GLASS

MUR/VITRE

1	Tassello e vite da muro	Wall plug and screw	Cheville et vis pour mur
2	Staffa piegata a 90°	90° bracket	Étrier plié à 90°
3	Cavo in acciaio	Steel cable	Câble en acier
4	Morsetto di regolazione	Adjusting clamp	Bride de réglage
5	Clip di aggancio	Attachment clip	Clip de fixation
6	Spessore legno	Wooden shim	Épaisseur en bois
7	Kit di collegamento clip e catena	Chain and clip connection kit	Kit de raccordement clip et chaîne
8	Kit di collegamento clip con snodo	Clip connection kit with joint	Kit de raccordement clip avec articulation
9	Biadesivo	Bi-adhesive film	Film adhésif double face
10	Aggancio rapido® femmina	Female Aggancio rapido® fitting	Aggancio rapido® femelle
11	Aggancio rapido® maschio	Male Aggancio rapido® fitting	Aggancio rapido® mâle

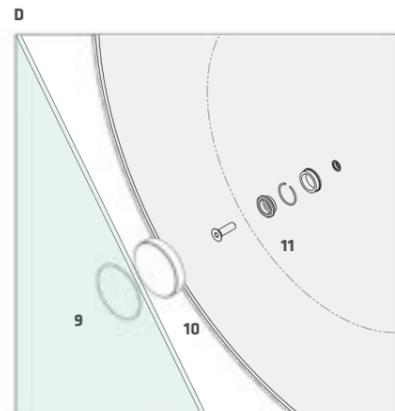
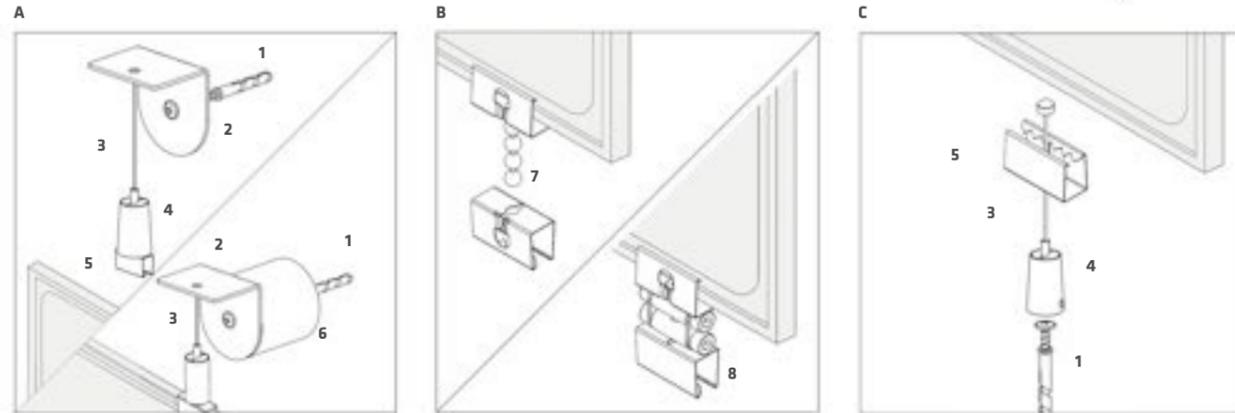
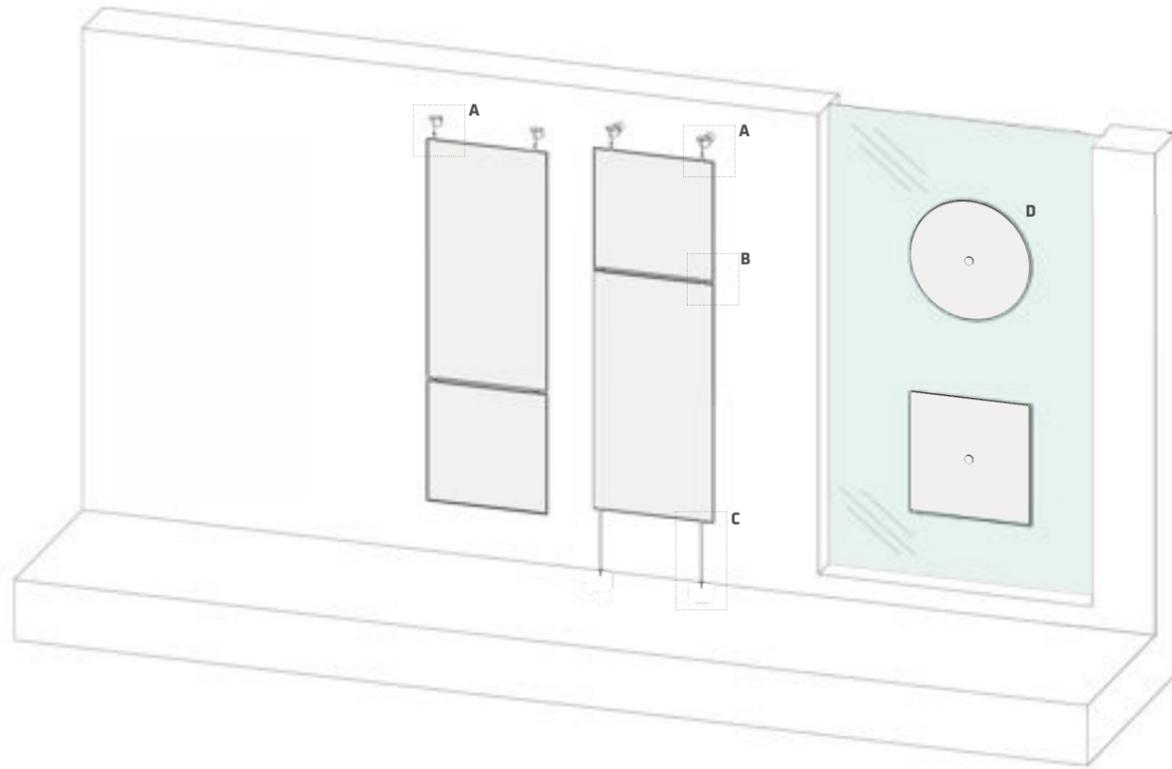

# AIRWIN

SOSPENSIONE TRIDIMENSIONALE

SUSPENDED 3D PANELS

SUSPENSION TRIDIMENSIONNELLE

1	Kit di collegamento clip con snodo	Clip connection kit with joint	Kit de raccordement clip avec articulation
2	Kit di sospensione a "Y" con 2 uscite	"Y" suspension kit with 2 outlets	Kit de suspension en « Y » avec 2 sorties
3	Morsetto di regolazione	Adjusting clamp	Bride de réglage
4	Cavo in acciaio	Steel cable	Câble en acier
5	Clip di aggancio	Attachment clip	Clip de fixation
6	Kit di collegamento clip e catena	Chain and clip connection kit	Kit de raccordement clip et chaîne
7	Kit di collegamento clip a 4 uscite	Clip connection kit with 4 outlets	Kit de raccordement clip à 4 sorties
8	Kit di fissaggio a soffitto con morsetto di regolazione	Ceiling mounting kit with adjusting clamp	Kit de fixation au plafond avec bride de réglage
9	Kit di collegamento clip a 6 uscite	Clip connection kit with 6 outlets	Kit de raccordement clip à 6 sorties

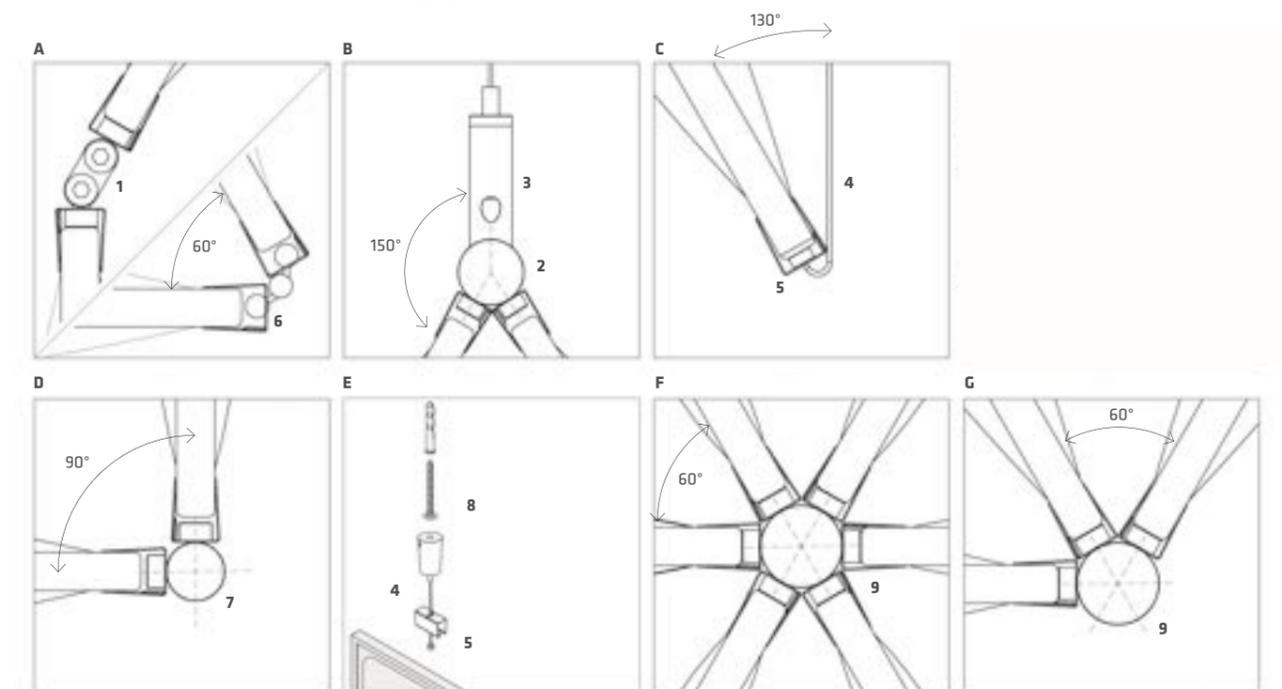
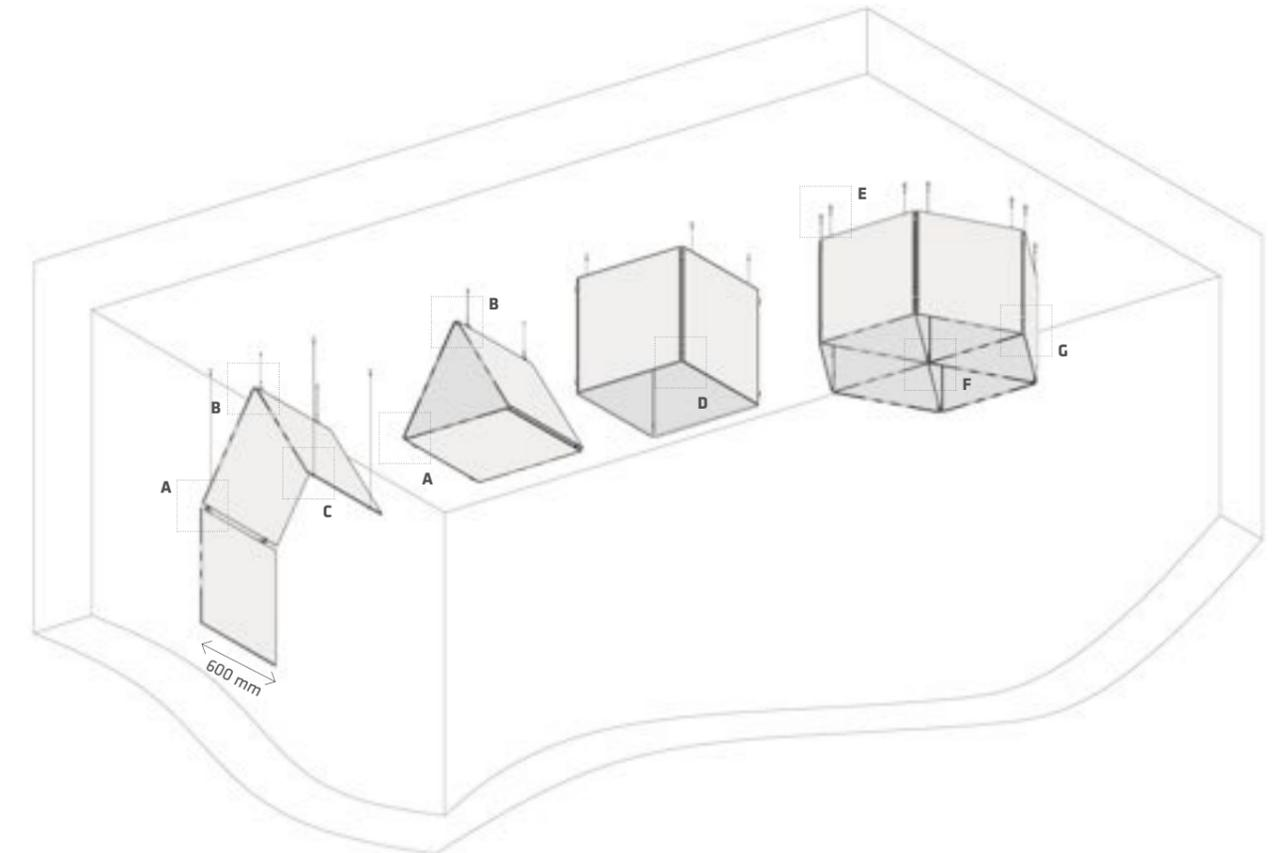

# AIRWIN

SOFFITTO  
SISTEMA DI ILLUMINAZIONE

CEILING  
LIGHTING SYSTEM

PLAFOND  
SYSTÈME D'ÉCLAIRAGE

1	Fascia di fissaggio per corpo illuminante "Point led quadrato"	Fixing band for square "Point led" luminaire	Sangle de fixation pour luminaire « Point LED carré »
2	Corpo illuminante "Point led quadrato"	"Square point led" luminaire	Luminaire « Point LED carré »
3	Fascia di fissaggio per corpo illuminante "Point led tondo"	Fixing band for round "Point led" luminaire	Sangle de fixation pour luminaire « Point LED rond »
4	Corpo illuminante "Point led tondo"	"Round point led" luminaire	Luminaire « Point LED rond »
5	Fascia di fissaggio per corpo illuminante "Tubes"	Fixing band for "Tubes" luminaire	Sangle de fixation pour luminaire « Tubes »
6	Cornice led a muro	LED-powered cornice system	Cadre lumineux mur LED

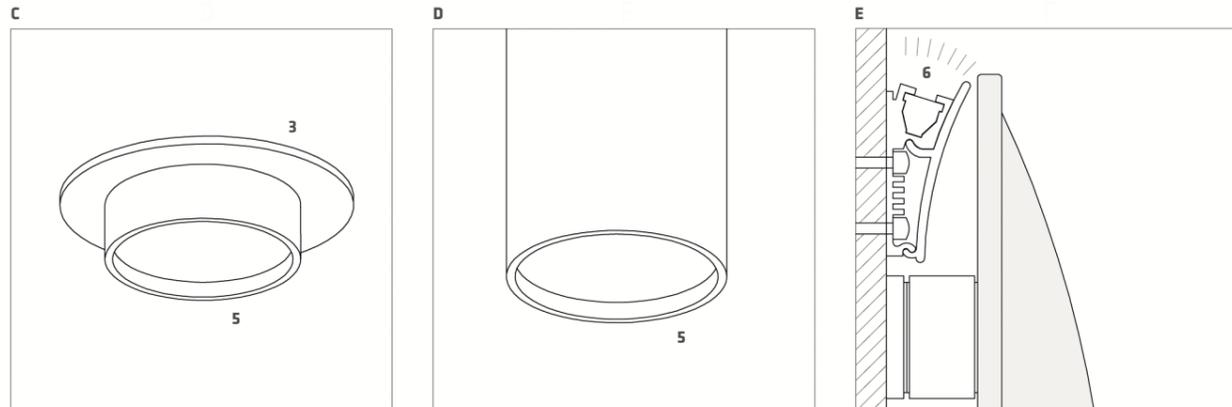
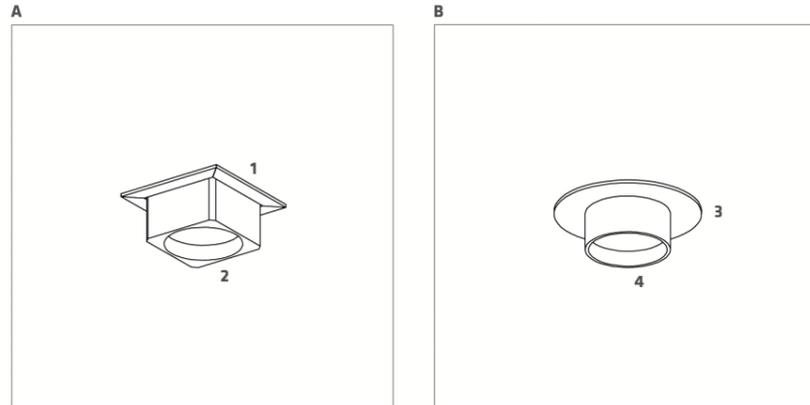
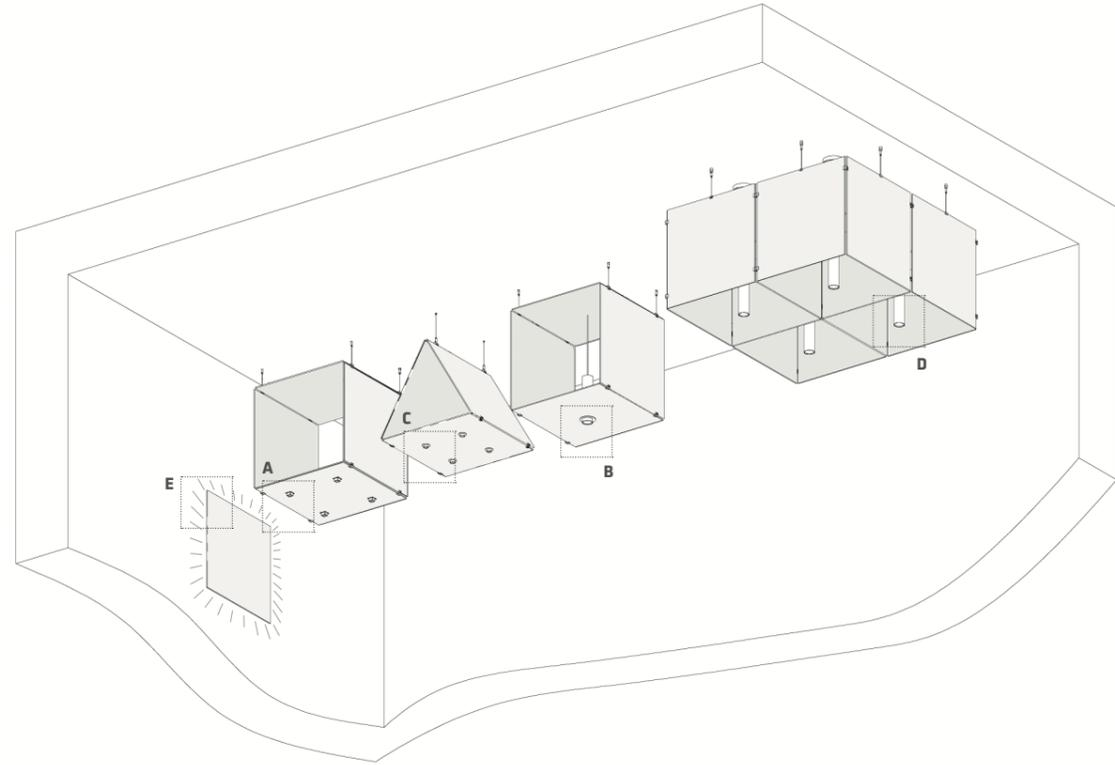

# AIRWIN EASYAIR

STANDALONE  
AGGANCIO RAPIDO®

STANDALONE  
AGGANCIO RAPIDO®

AUTOPORTANT  
AGGANCIO RAPIDO®

1	Palo verticale fissato alla base	Vertical pole fixed to base	Poteau vertical fixé à la base
2	Femmina per fissaggio al palo	Female fitting for fixing to pole	Femelle pour fixation au poteau
3	Maschio fissato al pannello	Male fitting fixed to panel	Mâle pour fixation au panneau

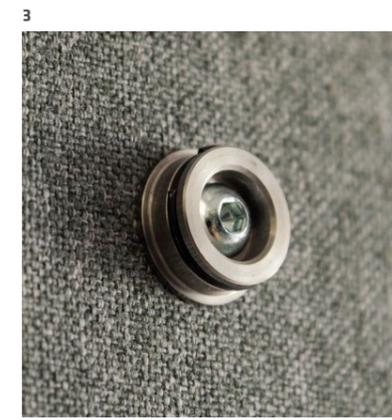
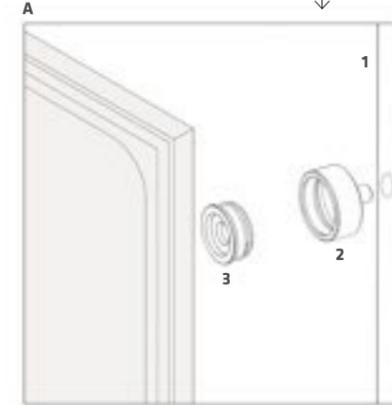
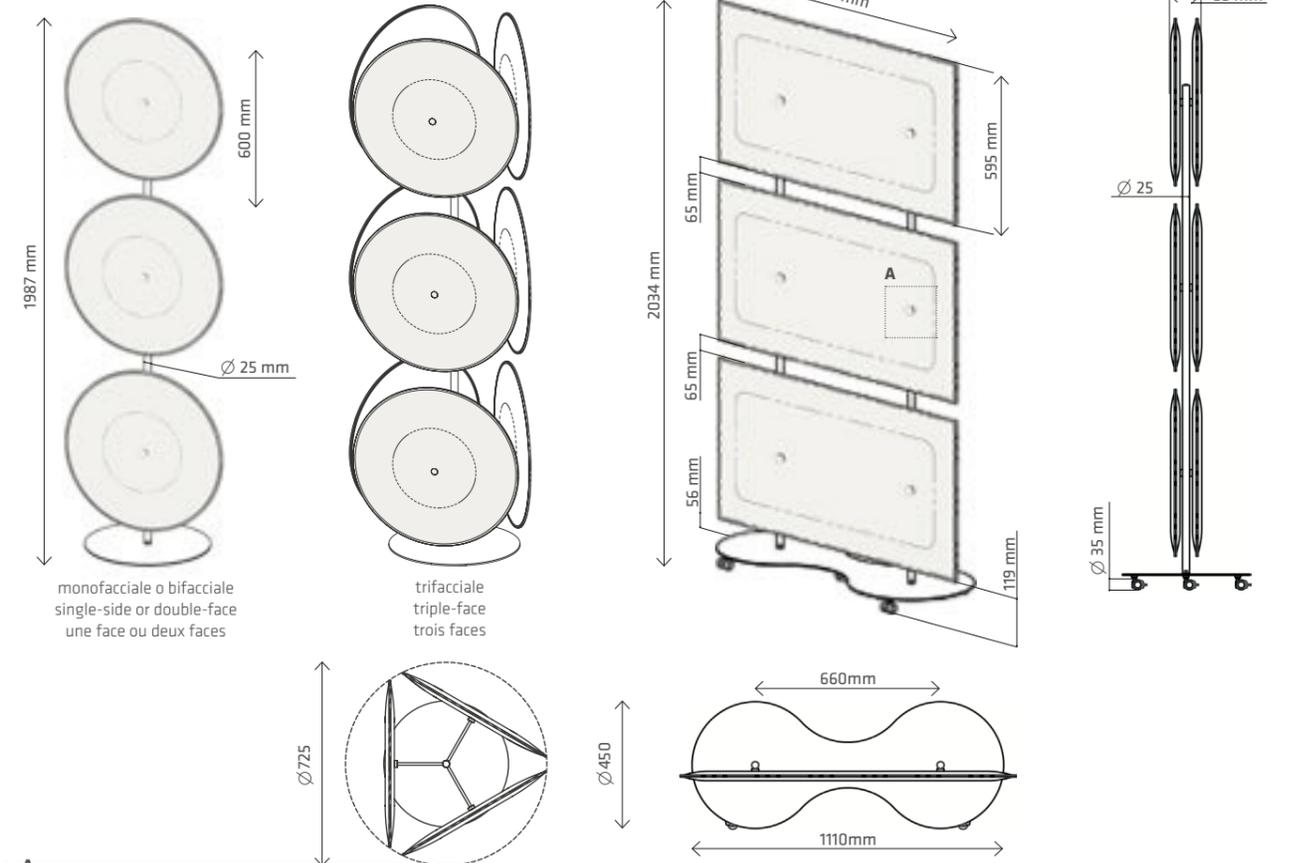

DETTAGLIO FOTOGRAFICO /  
PHOTOGRAPH DETAIL /  
DÉTAIL PHOTOGRAPHIQUE



# LISTEN DOGATO

## PARETE SISTEMA VARIOFIX

## WALL VARIOFIX SYSTEM

## MUR SYSTÈME VARIOFIX

1	Tassello e vite da muro	Wall plug and screw	Cheville et vis pour mur
2	Profilo a "J" di finitura	J-shaped finishing profile	Profilé en « J » de finition
3	Profilo ad Omega	Omega profile	Profilé en oméga
4	Feltro fono-assorbente	Sound-absorbing felt	Feutre insonorisant
5	Piastrina a "J" di partenza	J-shaped starting plate	Plaquette en « J » de départ
6	Vite auto-forante per fissaggio piastrine	Self-drilling screw for fixing plates	Vis autotaraudeuse pour la fixation des plaquettes
7	Piastrina "Variofix" di fissaggio	"Variofix" mounting plate	Plaquette « Variofix » de fixation
8	Doga Listen 19/2	19/2 Listen slat	Latte Listen 19/2
9	Piastrina a "J" di chiusura finale	J-shaped finishing plate	Plaquette en « J » de fermeture finale

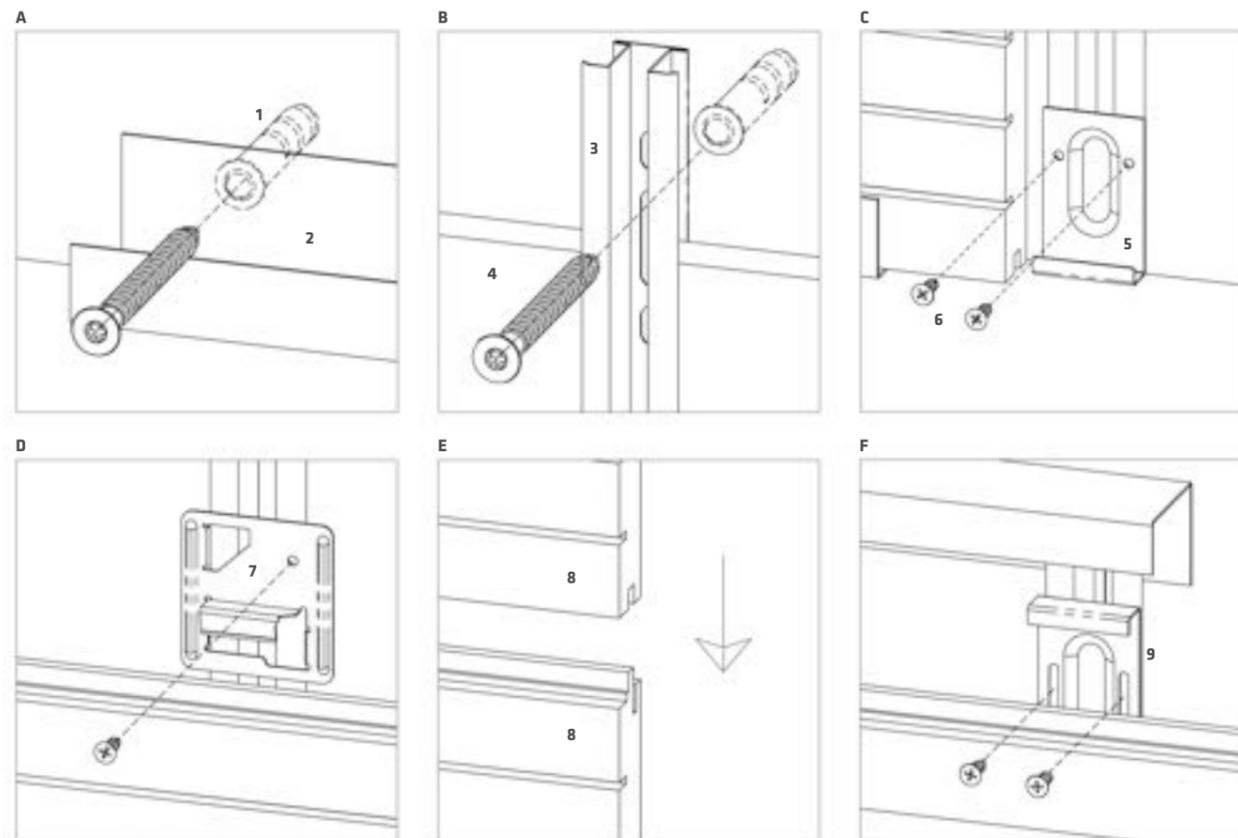
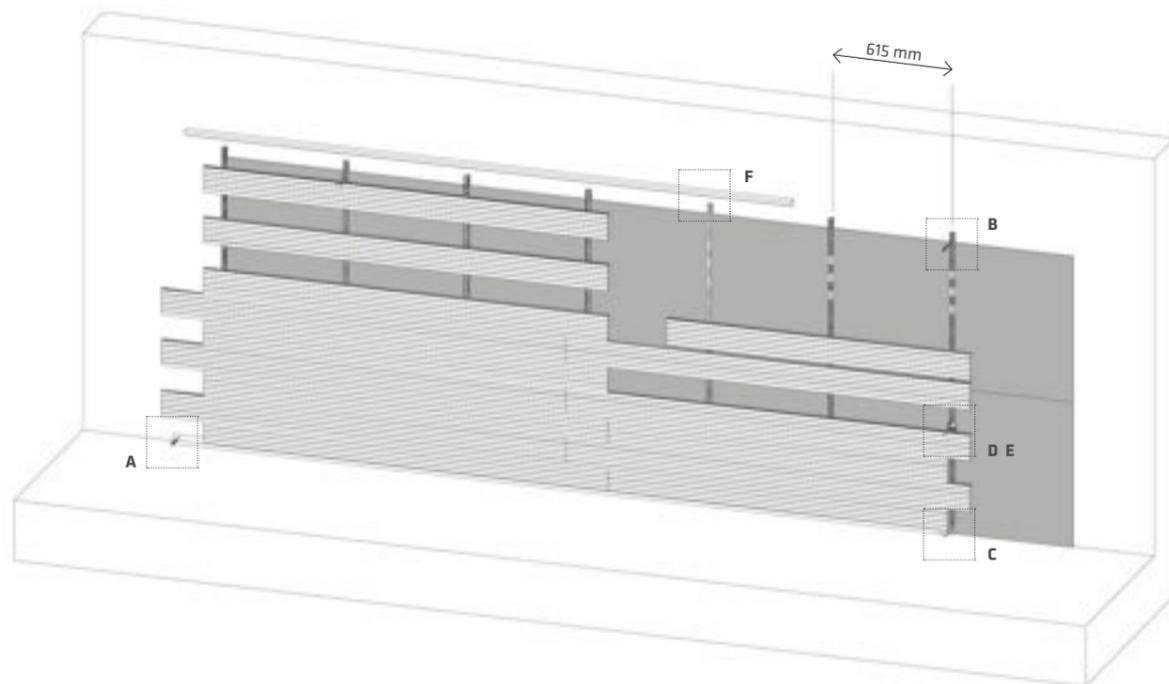

# LISTEN DOGATO

## SOFFITTO SISTEMA VARIOFIX

## CEILING VARIOFIX SYSTEM

## PLAFOND SYSTÈME VARIOFIX

1	Tassello e vite da muro	Wall plug and screw	Cheville et vis pour mur
2	Profilo a "J" di finitura	J-shaped finishing profile	Profilé en « J » de finition
3	Tassello a soffitto con rondella	Ceiling plug with washer	Cheville au plafond avec rondelle
4	Pendino superiore	Upper hanger	Tirant supérieur
5	Molla di regolazione a farfalla	Adjustment spring	Ressort de réglage
6	Pendino inferiore	Lower hanger	Tirant inférieur
7	Profilo ad omega	Omega profile	Profilé en oméga
8	Vite auto-forante	Self-drilling screw	Vis autotaraudeuse
9	Piastrina a "J" di partenza	J-shaped starting plate	Plaquette en « J » de départ
10	Doga listen	Listen slat	Latte Listen
11	Feltro fono-assorbente	Sound-absorbing felt	Feutre insonorisant
12	Piastrina "Variofix" di fissaggio	"Variofix" mounting plate	Plaquette « Variofix » de fixation

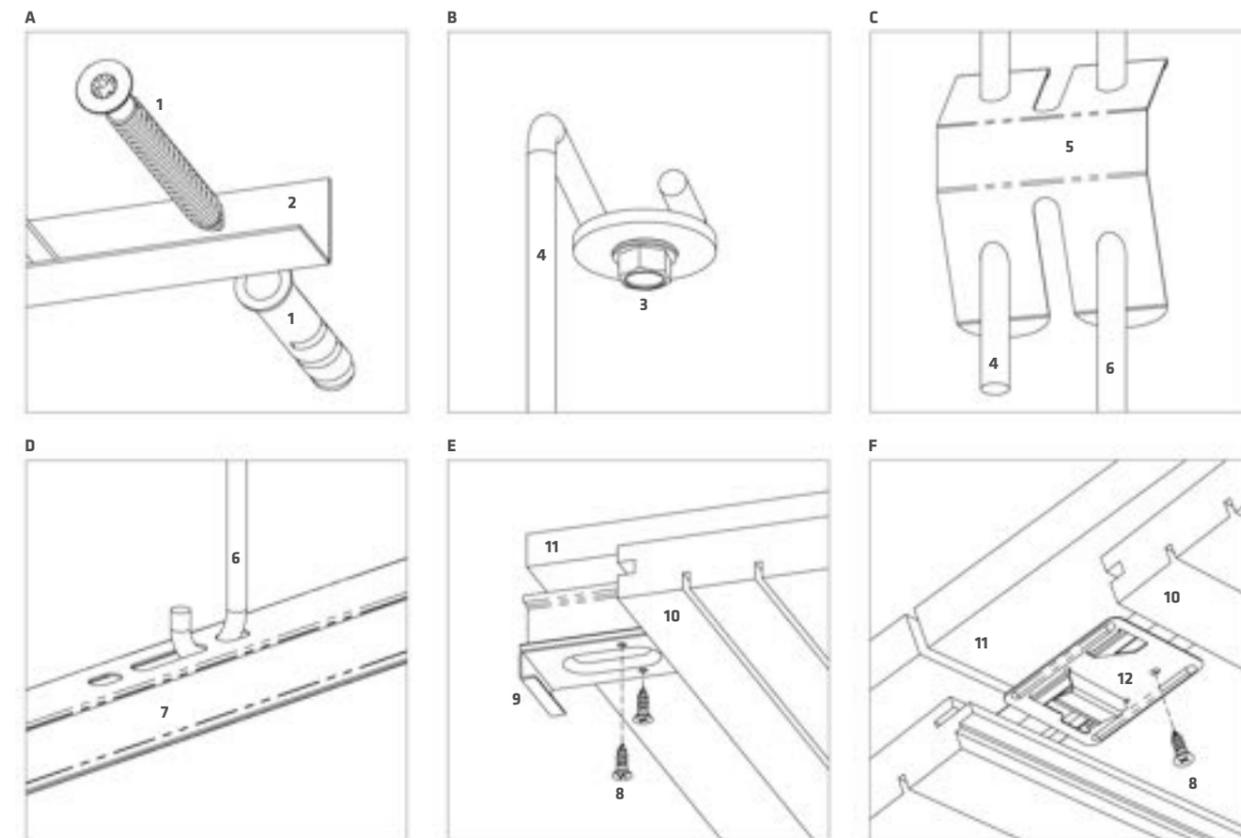
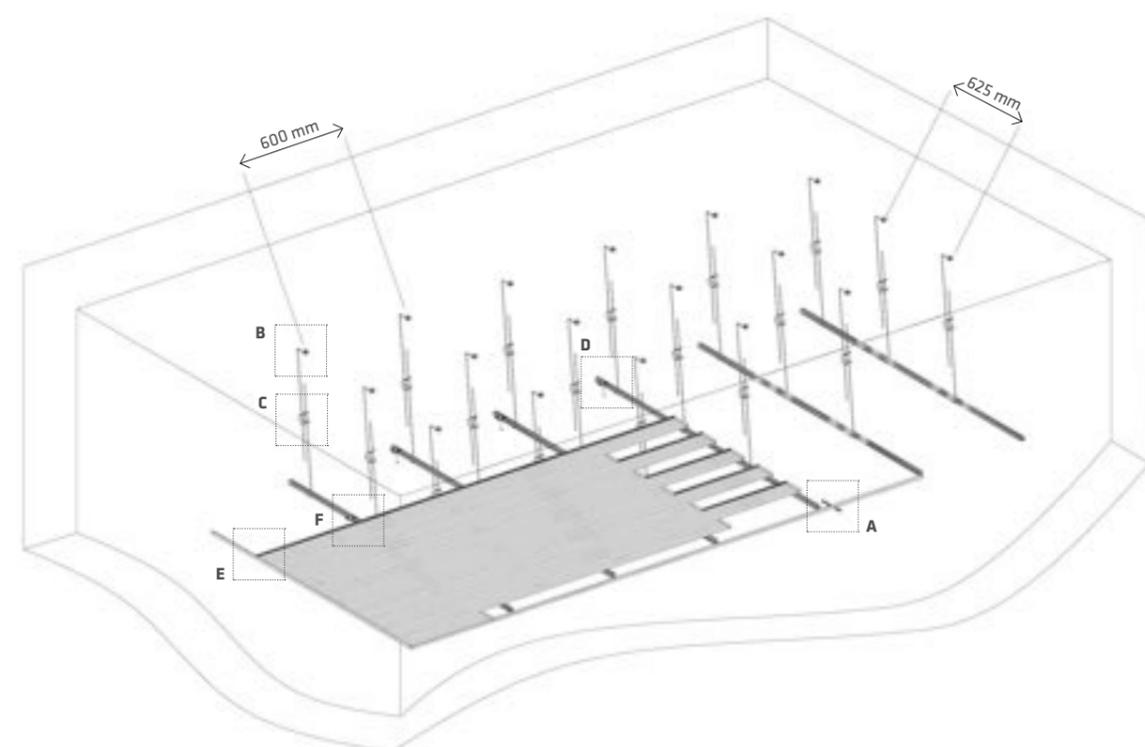

# LISTEN DOGATO CURVO

PARETE  
SISTEMA VARIOFIX

WALL  
VARIOFIX SYSTEM

MUR  
SYSTÈME VARIOFIX

1	Tassello e vite da muro	Wall plug and screw	Cheville et vis pour mur
2	Profilo a "J" di finitura	J-shaped finishing profile	Profilé en « J » de finition
3	Profilo ad Omega	Omega profile	Profilé en oméga
4	Feltro fono-assorbente	Sound-absorbing felt	Feutre insonorisant
5	Piastrina a "J" di partenza	J-shaped starting plate	Plaquette en « J » de départ
6	Vite auto-forante per fissaggio piastri	Self-drilling screw for fixing plates	Vis autotaraudeuse pour la fixation des plaquettes
7	Piastrina "Variofix" di fissaggio	"Variofix" mounting plate	Plaquette « Variofix » de fixation
8	Doga Listen 19/2	19/2 Listen slat	Latte Listen 19/2
9	Piastrina a "J" di chiusura finale	J-shaped finishing plate	Plaquette en « J » de fermeture finale

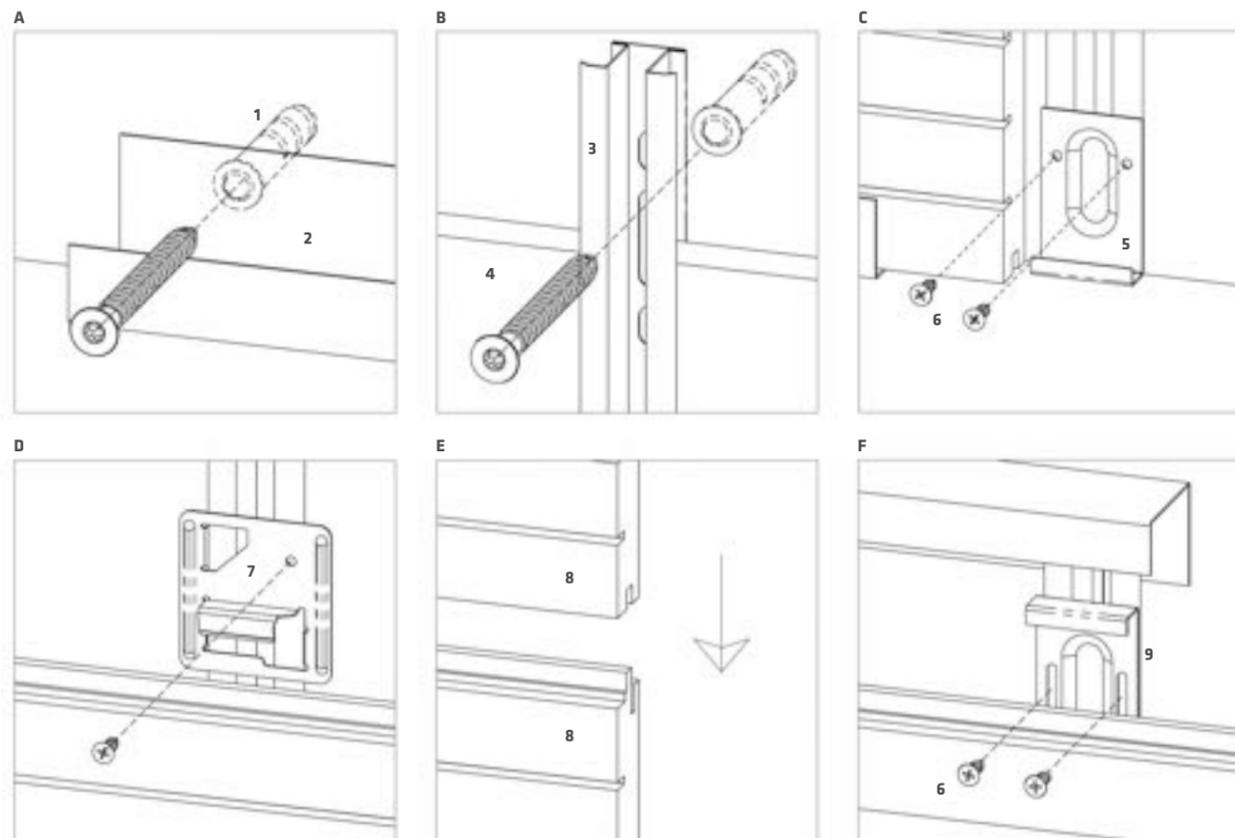
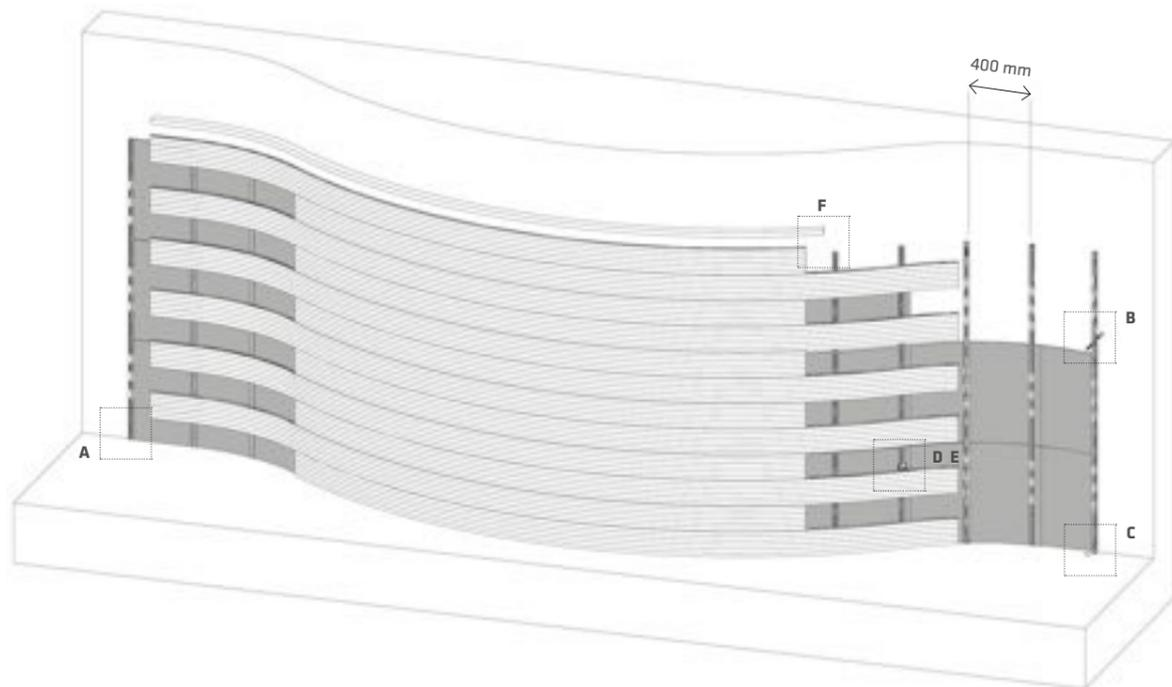

# LISTEN DOGATO CURVO

SOFFITTO  
SISTEMA VARIOFIX

CEILING  
VARIOFIX SYSTEM

PLAFOND  
SYSTÈME VARIOFIX

1	Tassello a soffitto con rondella	Ceiling plug with washer	Cheville au plafond avec rondelle
2	Pendino superiore	Upper hanger	Tirant supérieur
3	Molla di regolazione a farfalla	Adjustment spring	Ressort de réglage
4	Piastra "J" di collegamento	J-shaped connection plate	Plaquette « J » de liaison
5	Profilo 50 / 27	50 / 27 profile	Profilé 50 / 27
6	Profilo ad omega	Omega profile	Profilé en oméga
7	Vite auto-forante	Self-drilling screw	Vis autotaraudeuse
8	Piastrina a "J" di partenza	J-shaped starting plate	Plaquette en « J » de départ
9	Doga Listen con fresatura per curva	Listen slat with curved routing	Latte Listen avec fraisage pour courbe
10	Feltro fono-assorbente	Sound-absorbing felt	Feutre insonorisant
11	Piastrina "Variofix" di fissaggio	"Variofix" mounting plate	Plaquette « Variofix » de fixation

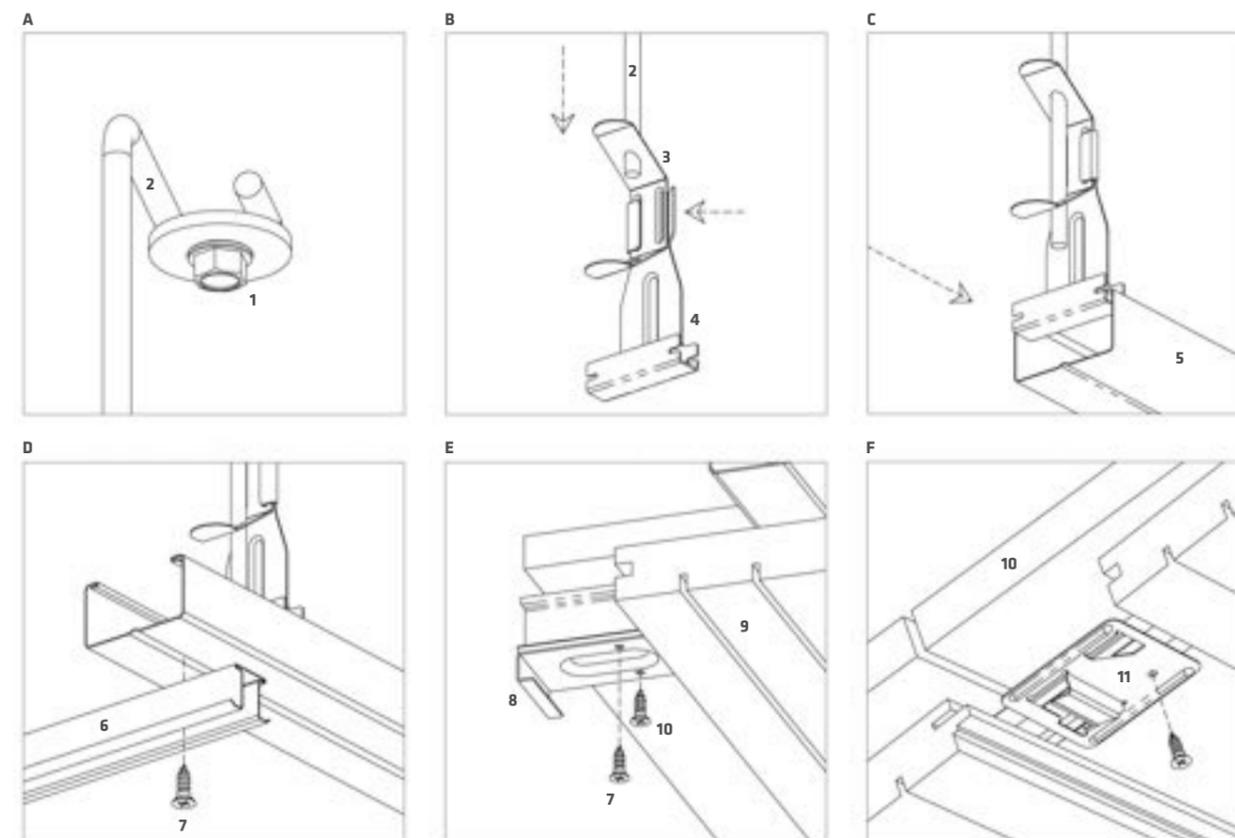
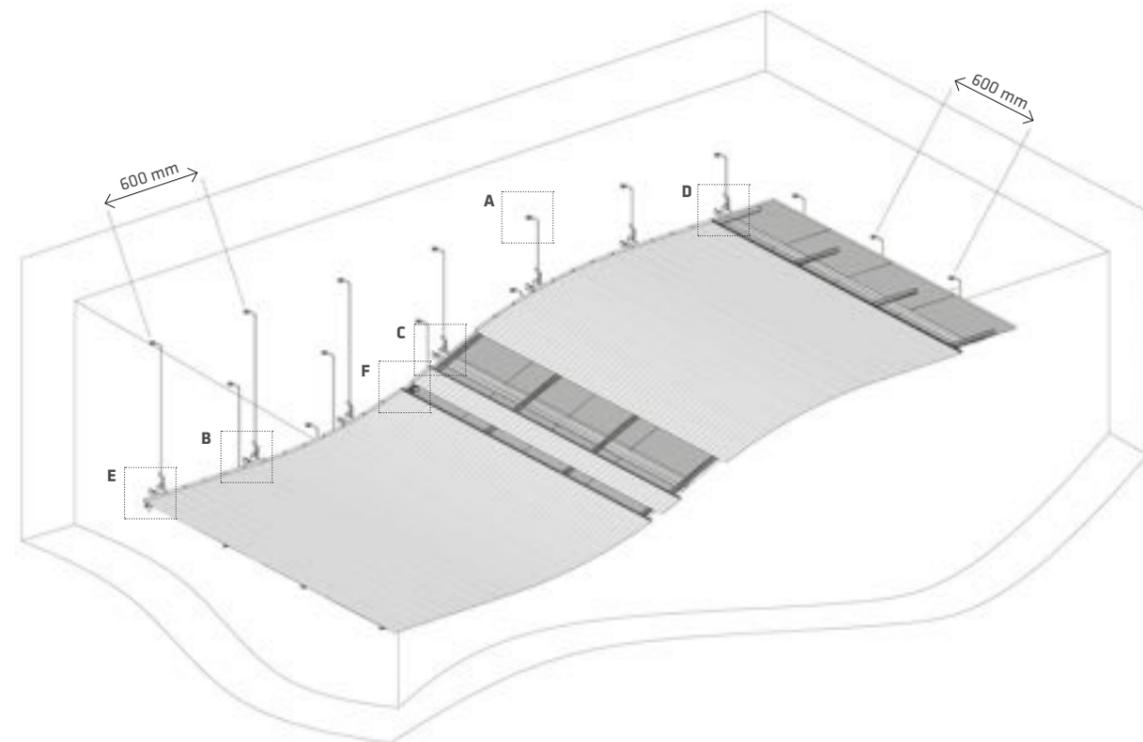

# LISTEN SQUARE

## SOFFITTO SISTEMA T24 A SCOMPARSA

## CEILING CONCEALED T24 SYSTEM

## PLAFOND SYSTÈME T24 ENCASTRE

1	Tassello e vite da muro	Wall plug and screw	Cheville et vis pour mur
2	Profilo a "L" di finitura	L-shaped finishing profile	Profilé en « L » de finition
3	Tassello a soffitto con rondella	Ceiling plug with washer	Cheville au plafond avec rondelle
4	Pendino superiore	Upper hanger	Tirant supérieur
5	Molla di regolazione a farfalla	Adjustment spring	Ressort de réglage
6	Pendino inferiore	Lower hanger	Tirant inférieur
7	Profilo T24	T24 profile	Profilé T24
8	Pannello Listen Square per T24 a scomparsa	Listen Square panel for concealed T24	Panneau Listen Square pour T24 encastré
9	Feltro fono-assorbente	Sound-absorbing felt	Feutre insonorisant
10	Traverso T24	T24 crosspiece	Traverse T24

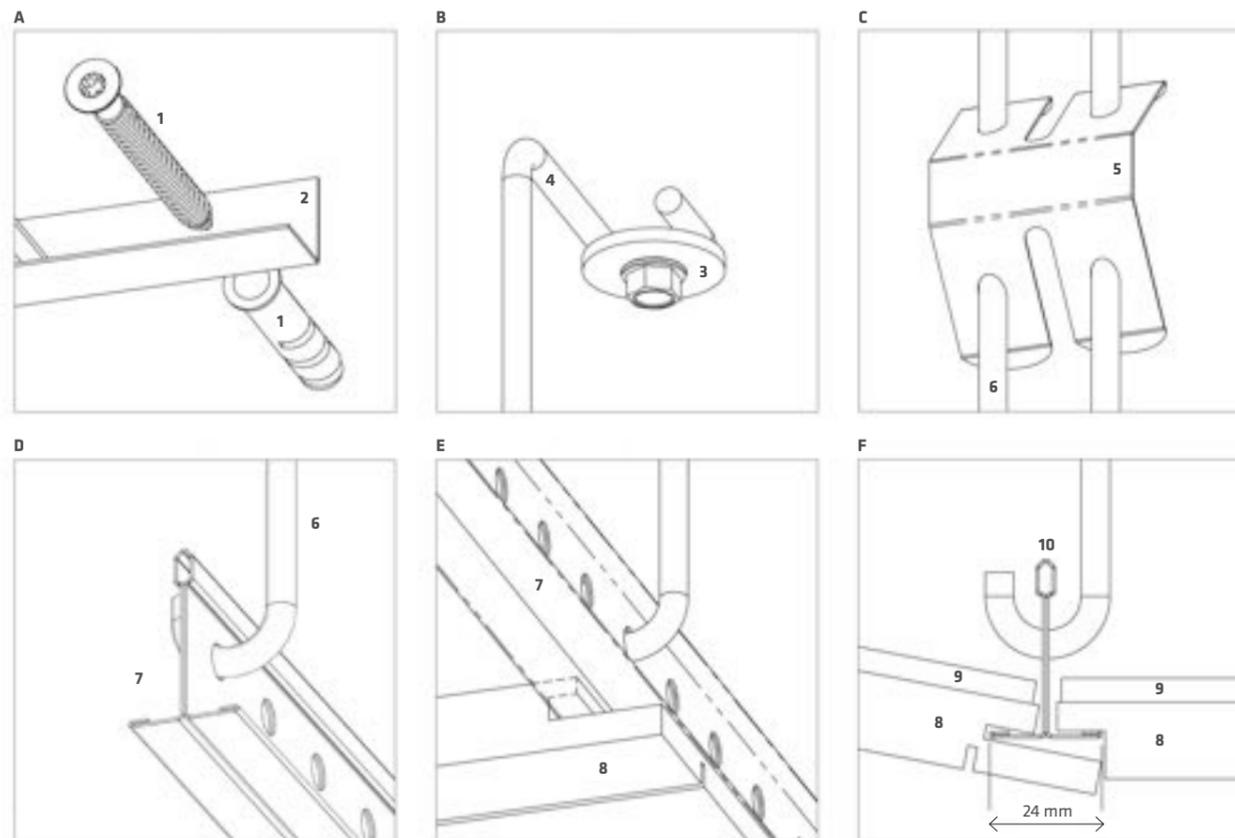
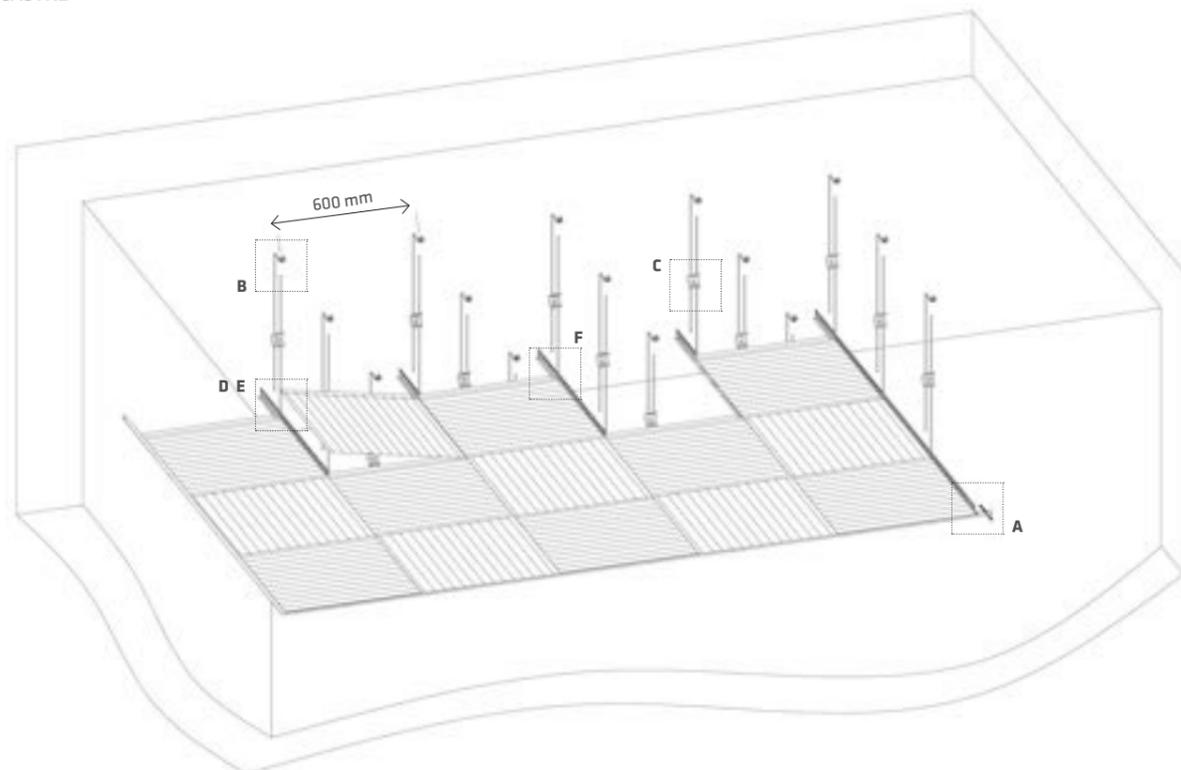

# LISTEN SQUARE

## SOFFITTO SISTEMA T24 A VISTA

## CEILING EXPOSED T24 SYSTEM

## PLAFOND SYSTÈME T24 APPARENT

1	Tassello e vite da muro	Wall plug and screw	Cheville et vis pour mur
2	Profilo a "L" di finitura	L-shaped finishing profile	Profilé en « L » de finition
3	Tassello a soffitto con rondella	Ceiling plug with washer	Cheville au plafond avec rondelle
4	Pendino superiore	Upper hanger	Tirant supérieur
5	Molla di regolazione a farfalla	Adjustment spring	Ressort de réglage
6	Pendino inferiore	Lower hanger	Tirant inférieur
7	Profilo T24	T24 profile	Profilé T24
8	Pannello Listen square	Listen square panel	Panneau Listen square
9	Traverso T24	T24 crosspiece	Traverse T24
10	Feltro fonoassorbente	Sound absorbing felt	Feutre insonorisant

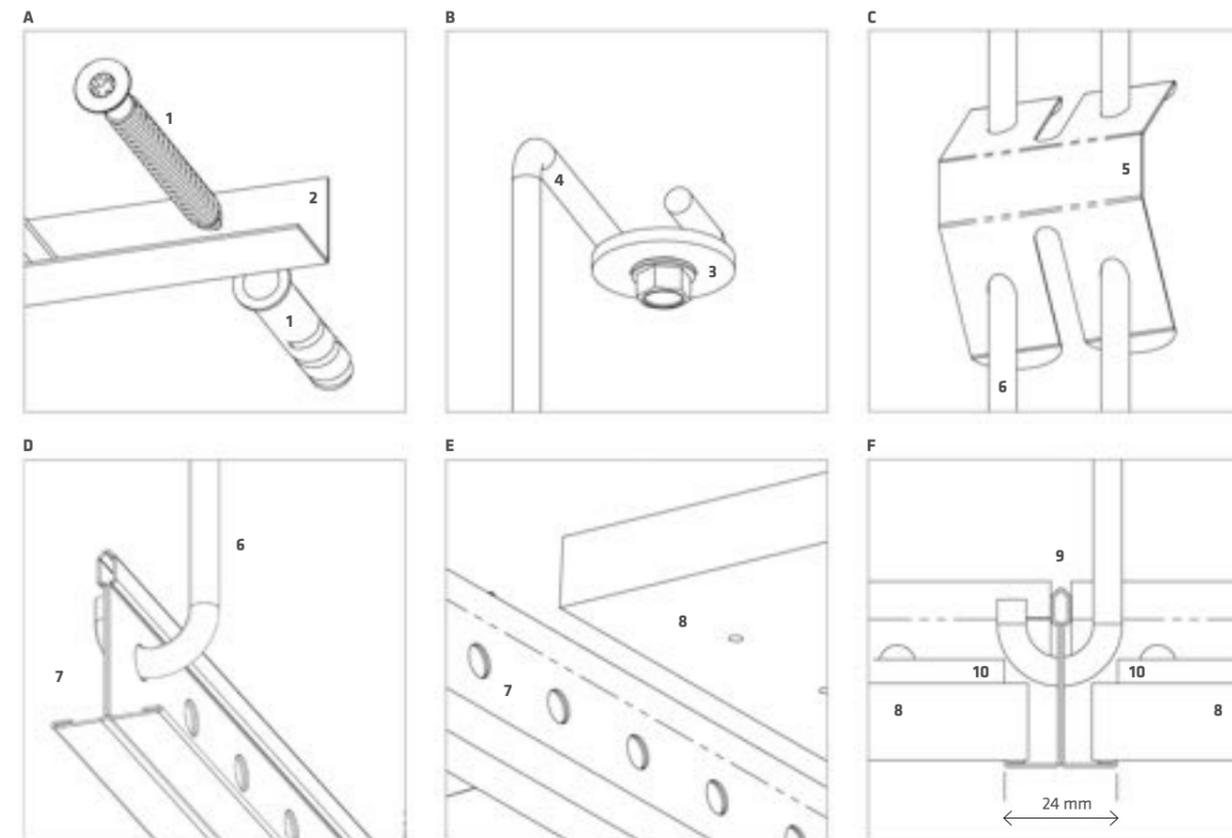
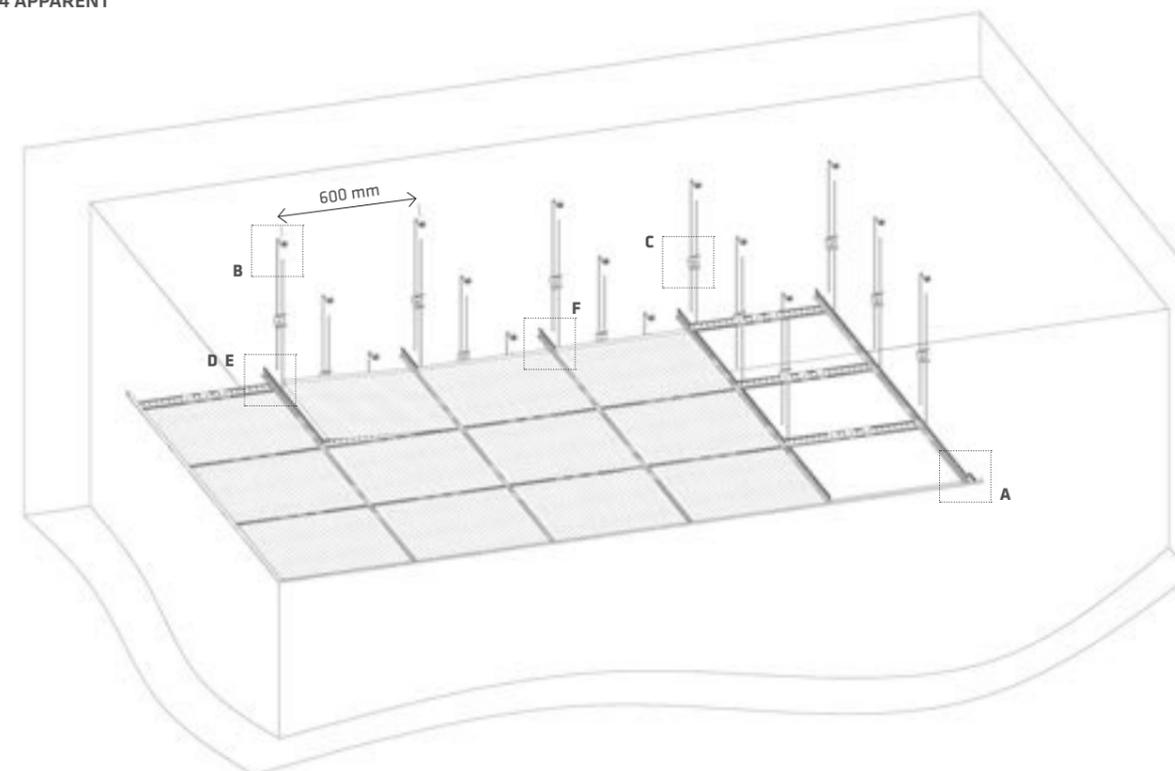

# LISTEN SQUARE

## SOFFITTO SISTEMA T15 SEMI-INCASSO

## CEILING SEMI-RECESSED T15 SYSTEM

## PLAFOND SYSTÈME T15 SEMI ENCASTRÉ

1	Tassello e vite da muro	Wall plug and screw	Cheville et vis pour mur
2	Profilo a "L" di finitura	L-shaped finishing profile	Profilé en « L » de finition
3	Tassello a soffitto con rondella	Ceiling plug with washer	Cheville au plafond avec rondelle
4	Pendino superiore	Upper hanger	Tirant supérieur
5	Farfalla di regolazione	Adjustment spring	Ressort de réglage
6	Pendino inferiore	Lower hanger	Tirant inférieur
7	Profilo T15	T15profile	Profilé T15
8	Pannello Listen Square a semi-incasso	Semi-recessed Listen Square panel	Panneau Listen Square semi encastré
9	Feltro fono-assorbente	Sound-absorbing felt	Feutre insonorisant
10	Traverso T15	T15 crosspiece	Traverse T15

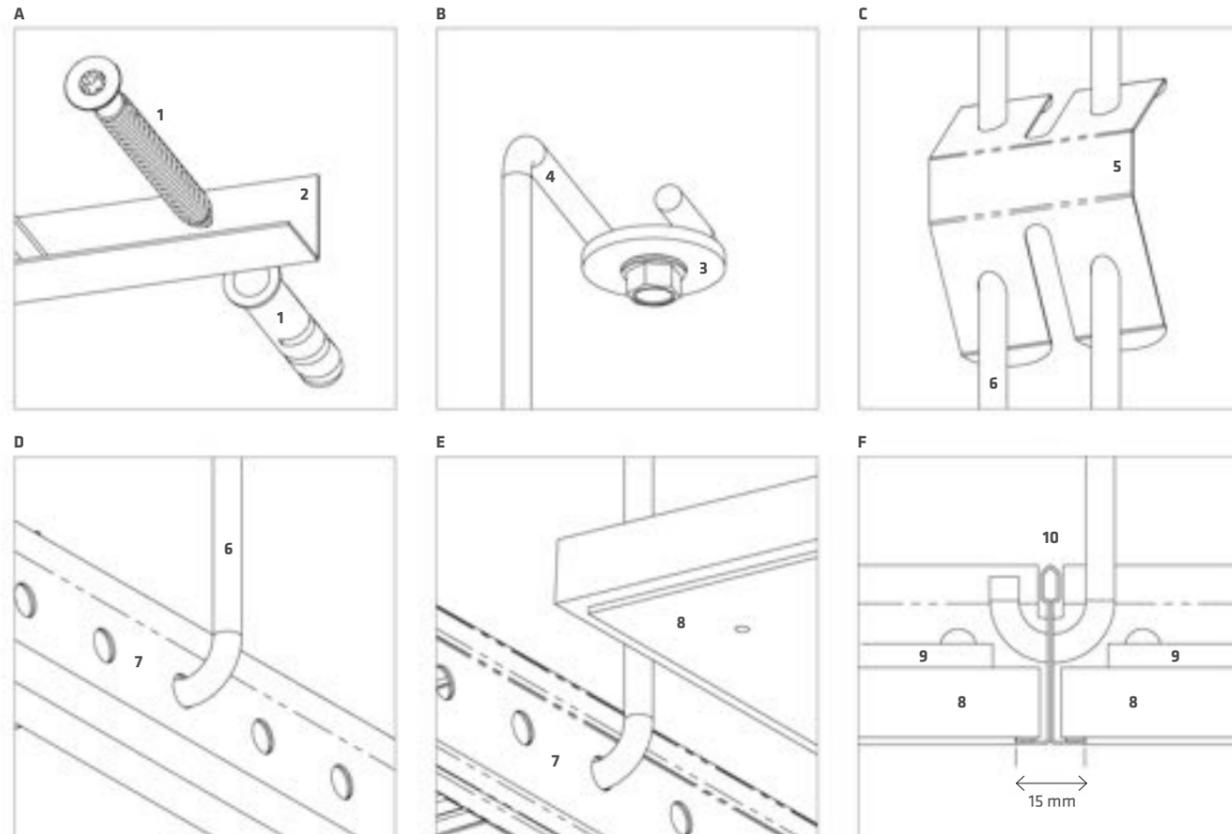
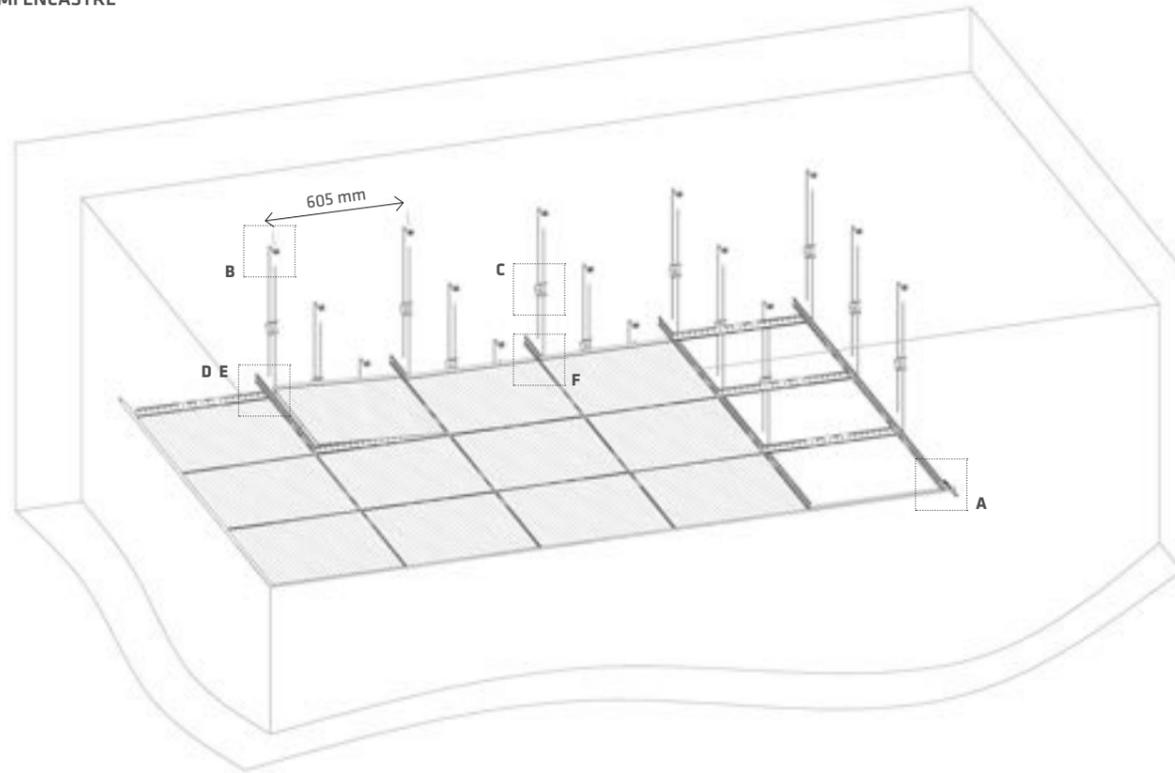

# LISTEN SQUARE

## SOFFITTO SISTEMA A SILHOUETTE

## CEILING SILHOUETTE SYSTEM

## PLAFOND SYSTÈME SILHOUETTE

1	Tassello e vite da muro	Wall plug and screw	Cheville et vis pour mur
2	Profilo a "L" di finitura	L-shaped finishing profile	Profilé en « L » de finition
3	Tassello a soffitto con rondella	Ceiling plug with washer	Cheville au plafond avec rondelle
4	Pendino superiore	Upper hanger	Tirant supérieur
5	Molla di regolazione a farfalla	Adjustment spring	Ressort de réglage
6	Pendino inferiore	Lower hanger	Tirant inférieur
7	Profilo Silhouette	Silhouette profile	Profilé Silhouette
8	Pannello Listen Square per Silhouette	Listen Square panel for Silhouette	Panneau Listen Square pour Silhouette
9	Feltro fono-assorbente	Sound-absorbing felt	Feutre insonorisant
10	Traverso Silhouette	Silhouette crosspiece	Traverse Silhouette

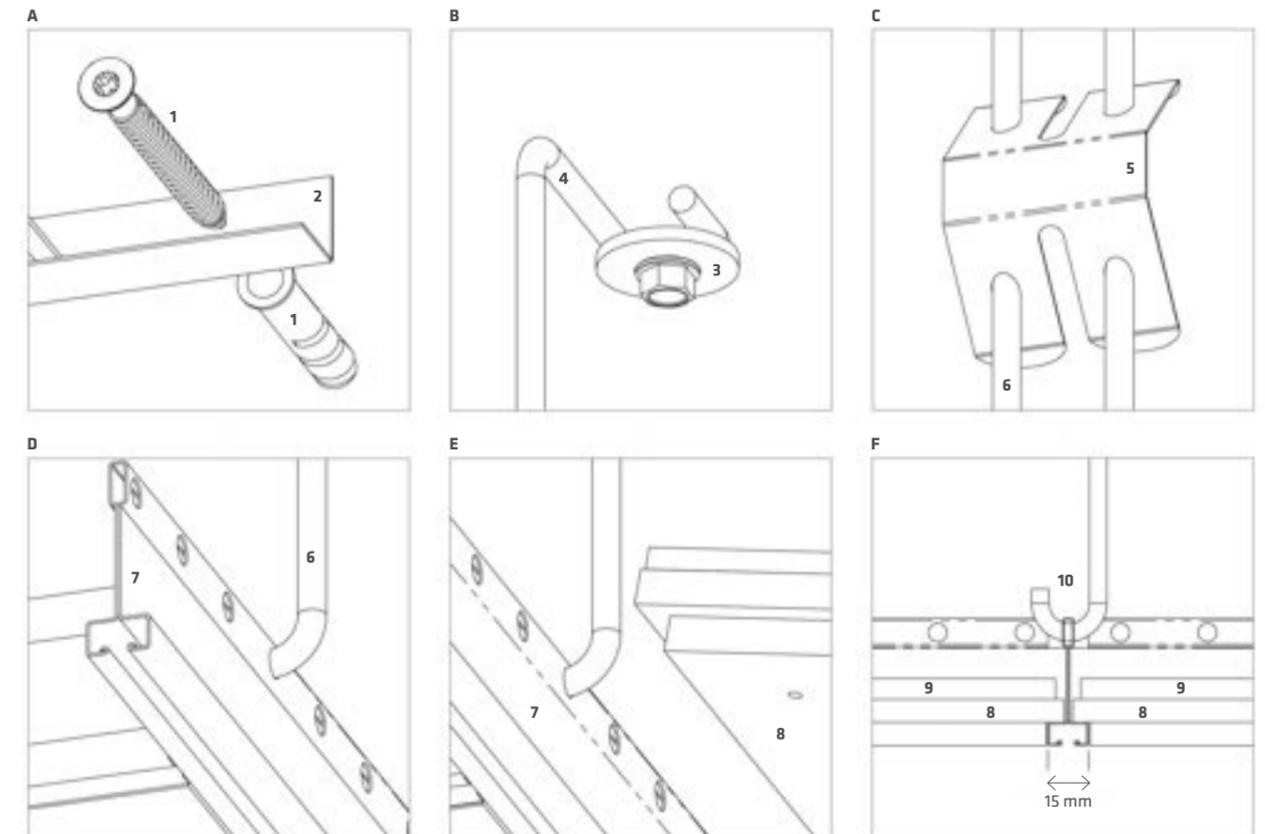
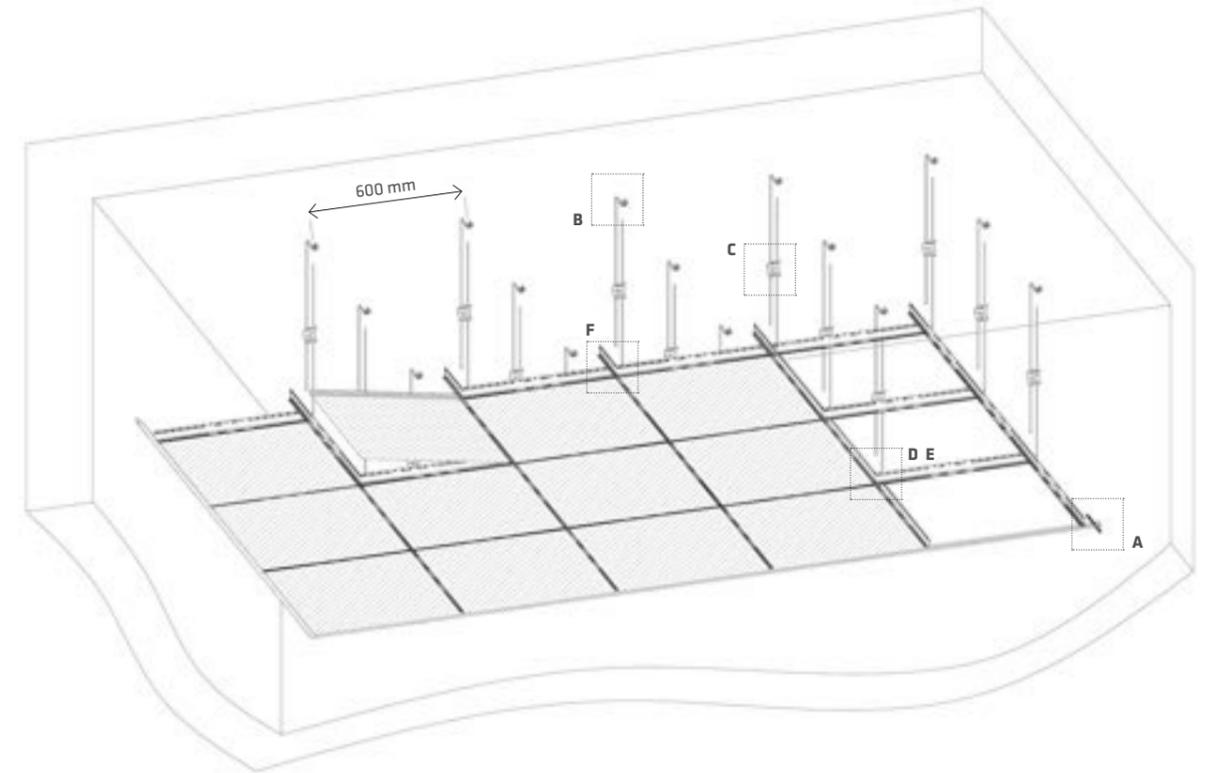

# CONCRETECH PETRA

## PARETE SISTEMA BRICK SYSTEM

## WALL BRICK SYSTEM

## MUR SYSTÈME BRICK SYSTEM

1	Tassello e vite da muro	Wall plug and screw	Cheville et vis pour mur
2	Profilo a "J" di finitura	J-shaped finishing profile	Profilé en « J » de finition
3	Profilo ad Omega	Omega profile	Profilé en oméga
4	Feltro fono-assorbente	Sound-absorbing felt	Feutre insonorisant
5	Piastrina a "J" di partenza	J-shaped finishing profile	Plaquette en « J » de départ
6	Vite auto-forante per fissaggio piastri	Self-drilling screw for fixing plates	Vis autotaraudeuse pour la fixation des plaquettes
7	Piastrina "Brick system" di fissaggio	"Brick system" mounting plate	Plaquette « Brick system » de fixation
8	Pannello Concretech 60x60 forato	Concretech 60x60 perforated panel	Panneau Concretech 60 x 60 perforé
9	Piastrina a "J" di chiusura finale	J-shaped finishing plate	Plaquette en « J » de fermeture finale

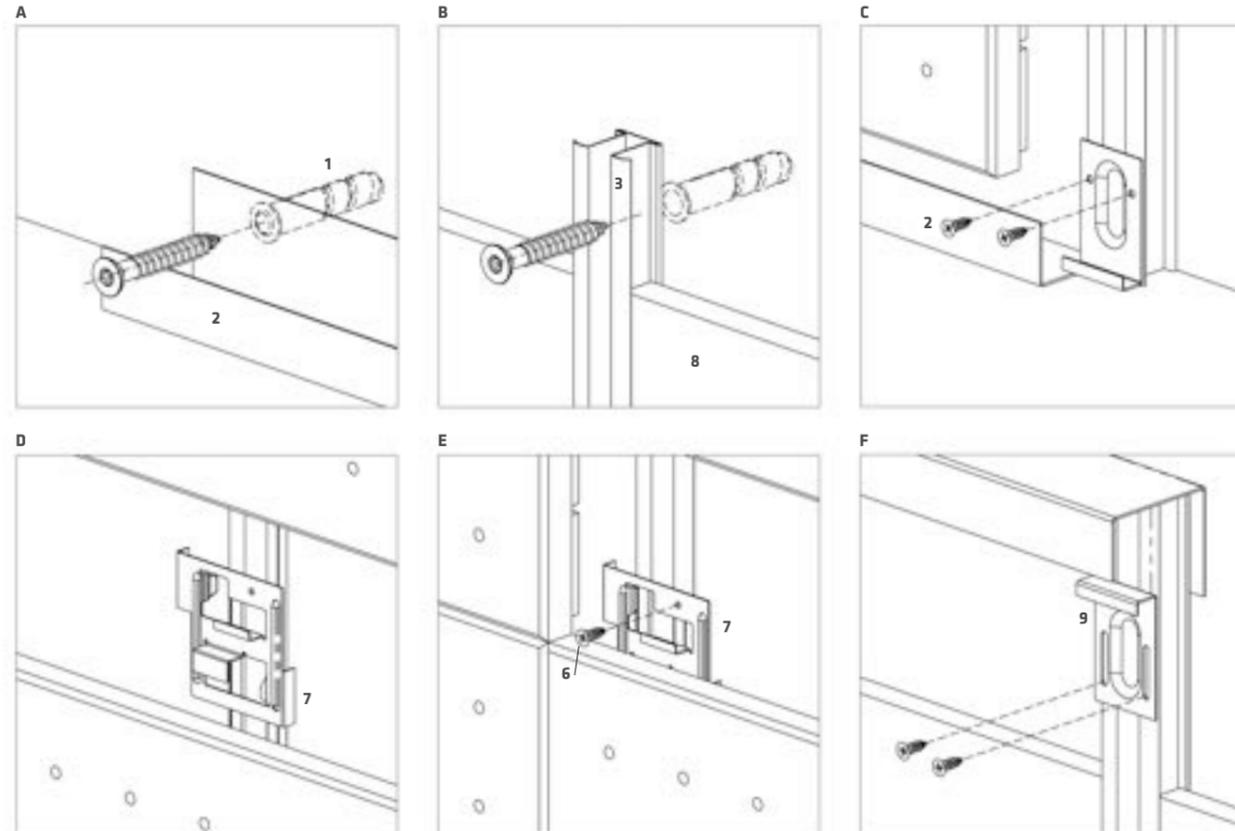
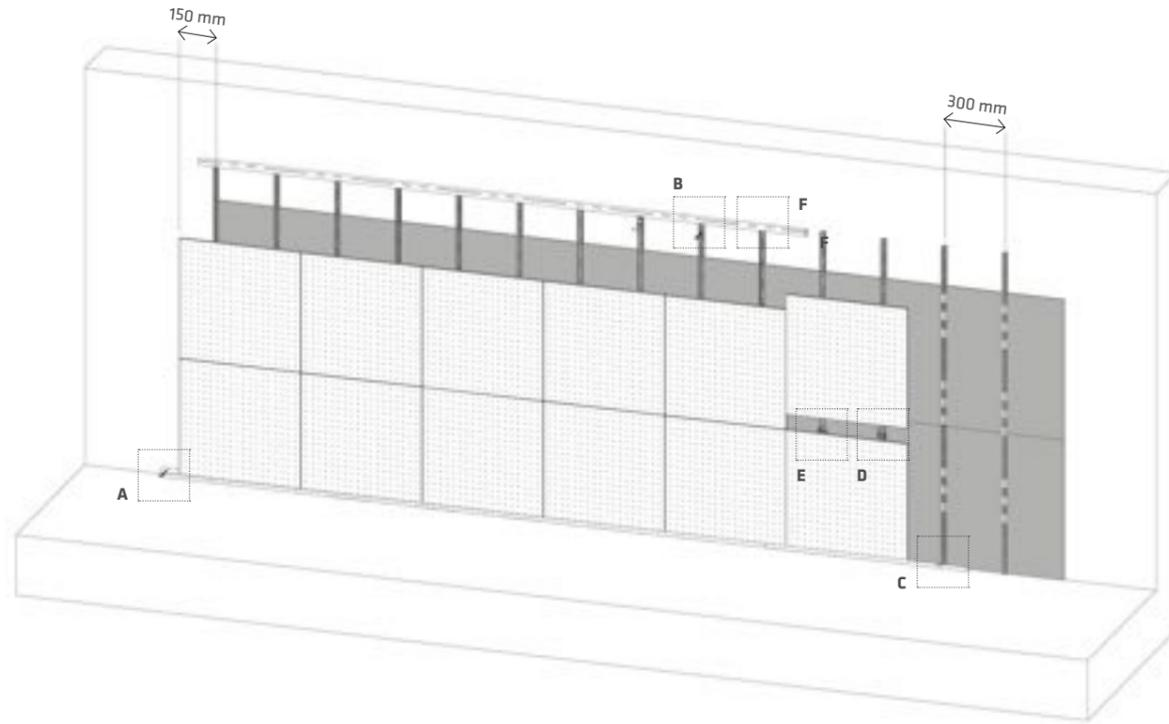

# CONCRETECH PETRA

## SOFFITTO SISTEMA A SILHOUETTE

## CEILING SILHOUETTE SYSTEM

## PLAFOND SYSTÈME SILHOUETTE

1	Tassello e vite da muro	Wall plug and screw	Cheville et vis pour mur
2	Profilo a "L" di finitura	L-shaped finishing profile	Profilé en « L » de finition
3	Tassello a soffitto con rondella	Ceiling plug with washer	Cheville au plafond avec rondelle
4	Pendine superiore	Upper hanger	Tirant supérieur
5	Farfalla di regolazione	Adjustment spring	Ressort de réglage
6	Pendine inferiore	Lower hanger	Tirant inférieur
7	Profilo Silhouette	Silhouette profile	Profilé Silhouette
8	Pannello Concretech per Silhouette	Concretech panel for Silhouette	Panneau Concretech pour Silhouette
9	Feltro fono-assorbente	Sound-absorbing felt	Feutre insonorisant
10	Traverso Silhouette	Silhouette crosspiece	Traverse Silhouette

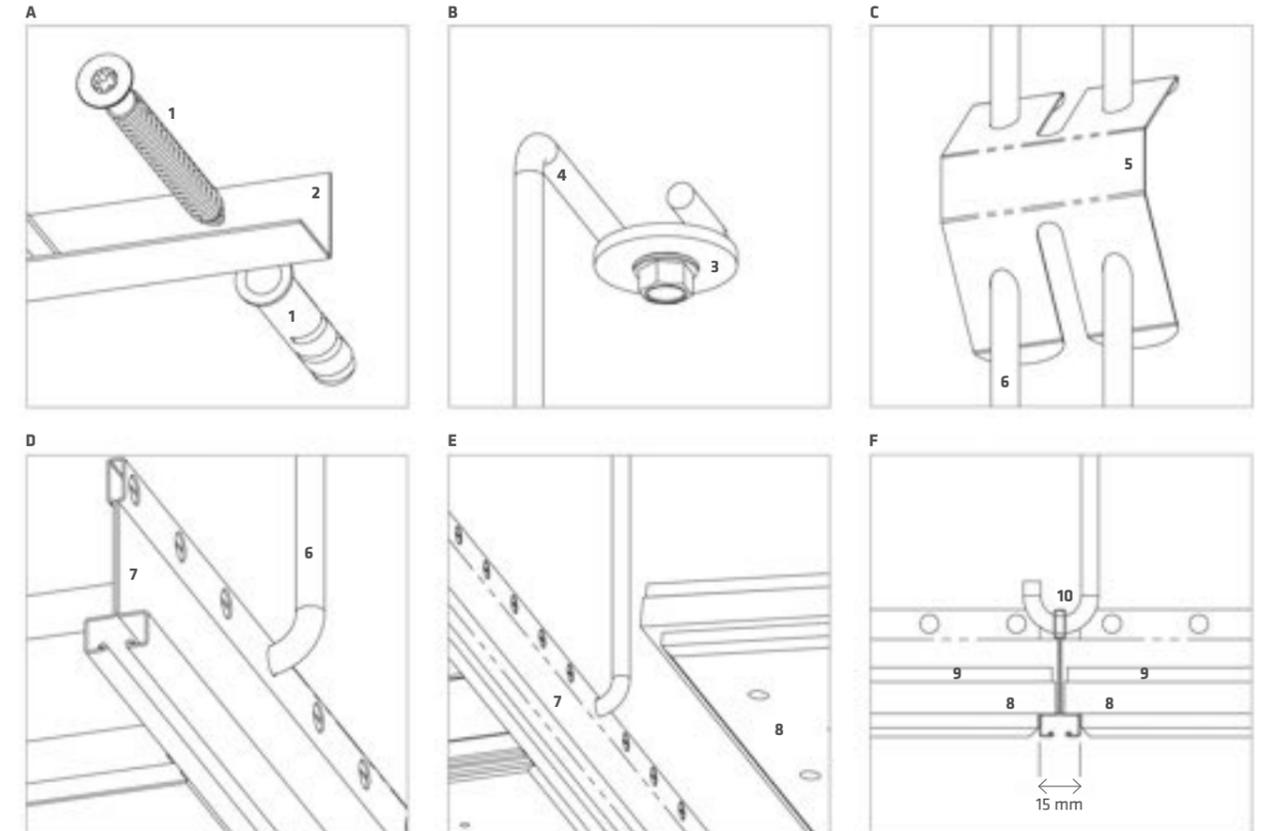
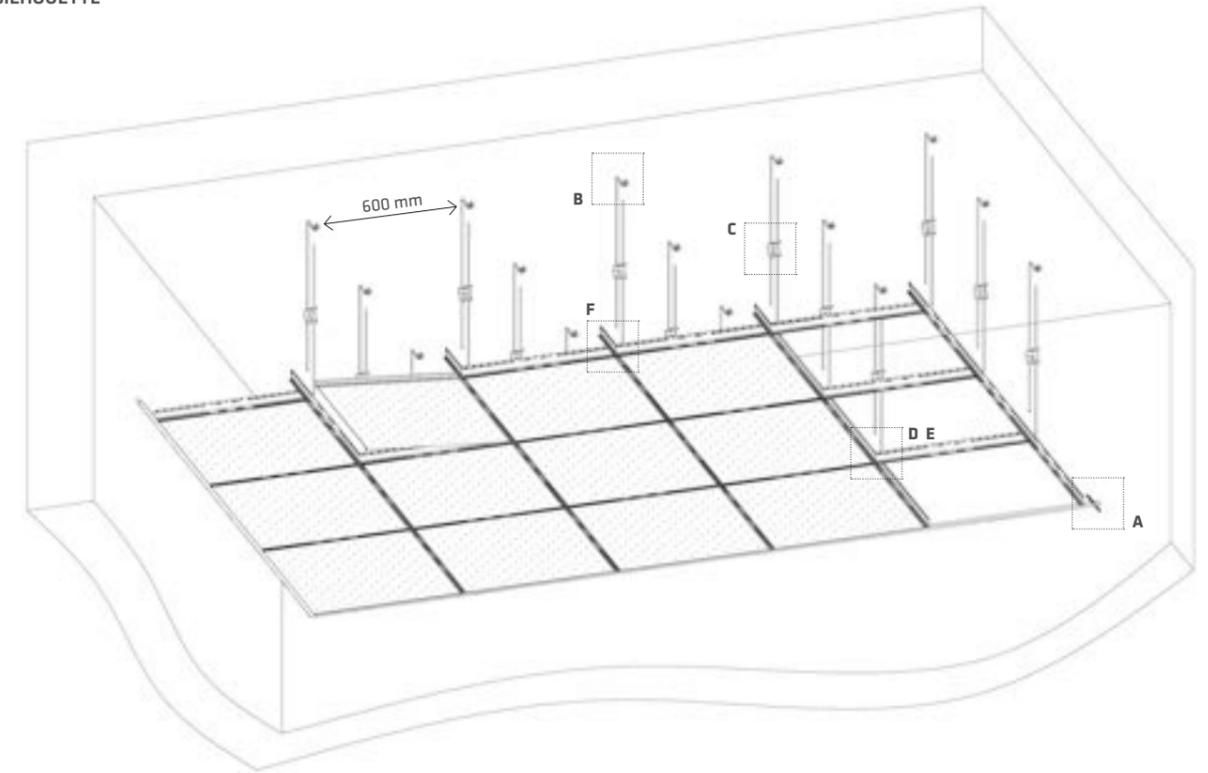

# DECORVOX

PARETE  
BRICK SYSTEM

WALL  
BRICK SYSTEM

MUR  
SYSTÈME  
BRICK SYSTEM

1	Tassello e vite da muro	Wall plug and screw	Cheville et vis pour mur
2	Profilo a "J" di finitura	J-shaped finishing profile	Profilé en « J » de finition
3	Profilo ad Omega	Omega profile	Profilé en oméga
4	Feltro fono-assorbente	Sound-absorbing felt	Feutre insonorisant
5	Piastrina a "J" di partenza	J-shaped starting plate	Plaquette en « J » de départ
6	Vite auto-forante per fissaggio piastrelle	Self-drilling screw for fixing plates	Vis autotaraudeuse pour la fixation des plaquettes
7	Piastrina "Brick system" di fissaggio	"Brick system" mounting plate	Plaquette « Brick system » de fixation
8	Pannello Decorvox 60x60	60x60 Decorvox panel	Panneau Decorvox 60 x 60
9	Piastrina a "J" di chiusura finale	J-shaped finishing plate	Plaquette en « J » de fermeture finale

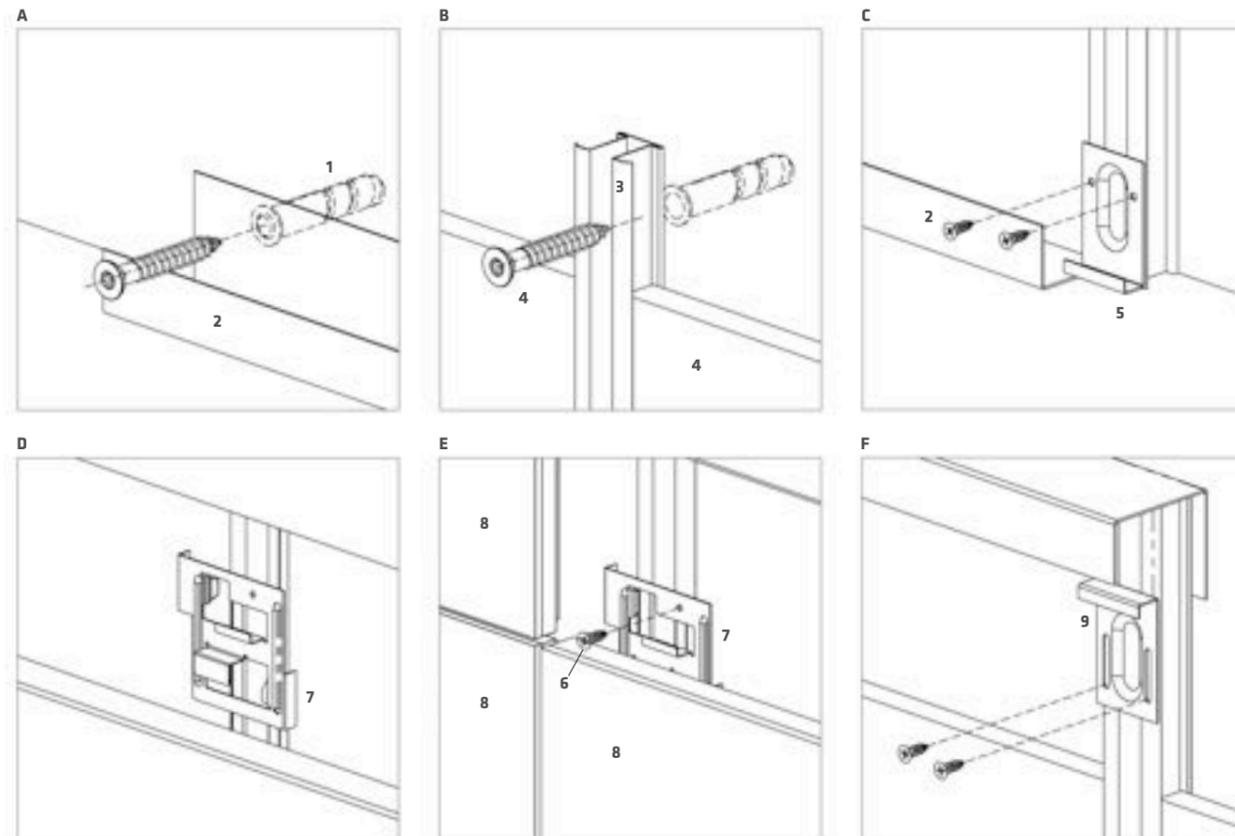
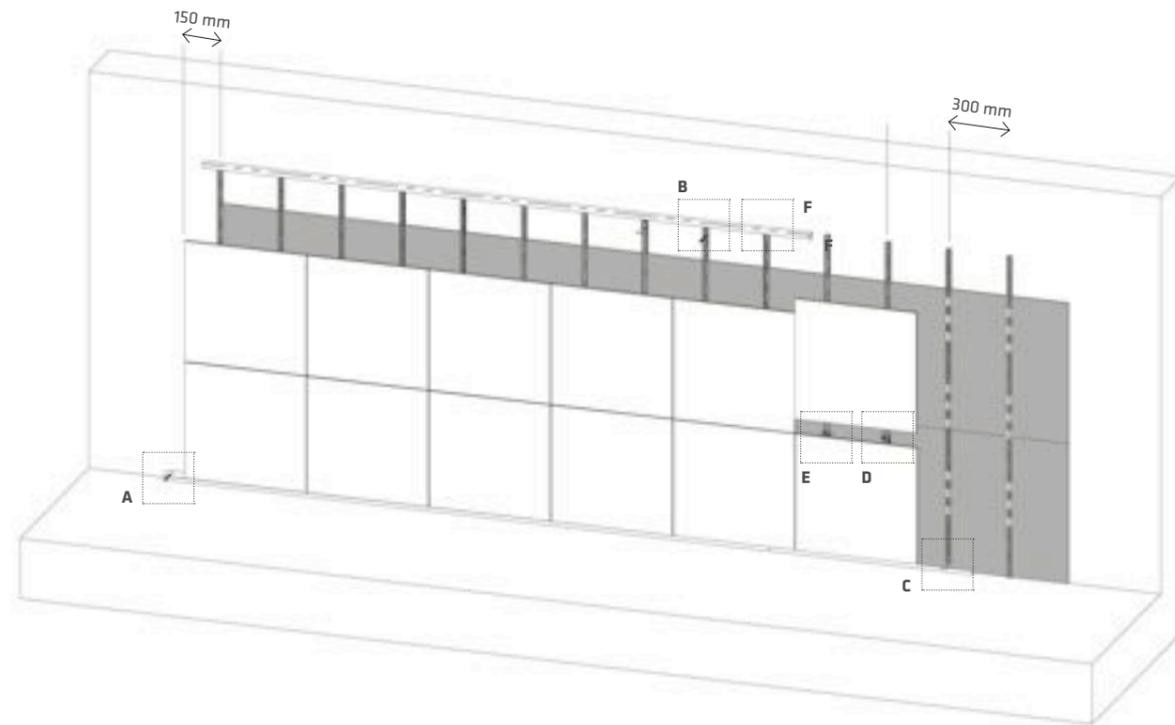

# METALIA

PARETE  
SISTEMA M32

WALL  
M32 SYSTEM

MUR  
SYSTÈME M32

1	tassello e vite da muro	Wall plug and screw	Cheville et vis pour mur
2	Profilo ad Omega	Omega profile	Profilé en oméga
3	Dima di posizionamento	Positioning jig	Gabarit de positionnement
4	Pannello in lamiera + feltro interno	Sheet metal panel + internal felt	Panneau en tôle + feutre interne
5	Vite auto-forante di sicurezza	Self-drilling security screw	Vis autotaraudeuse de sécurité
6	Profilo ad "L" di finitura	L-shaped finishing profile	Profilé en « L » de finition

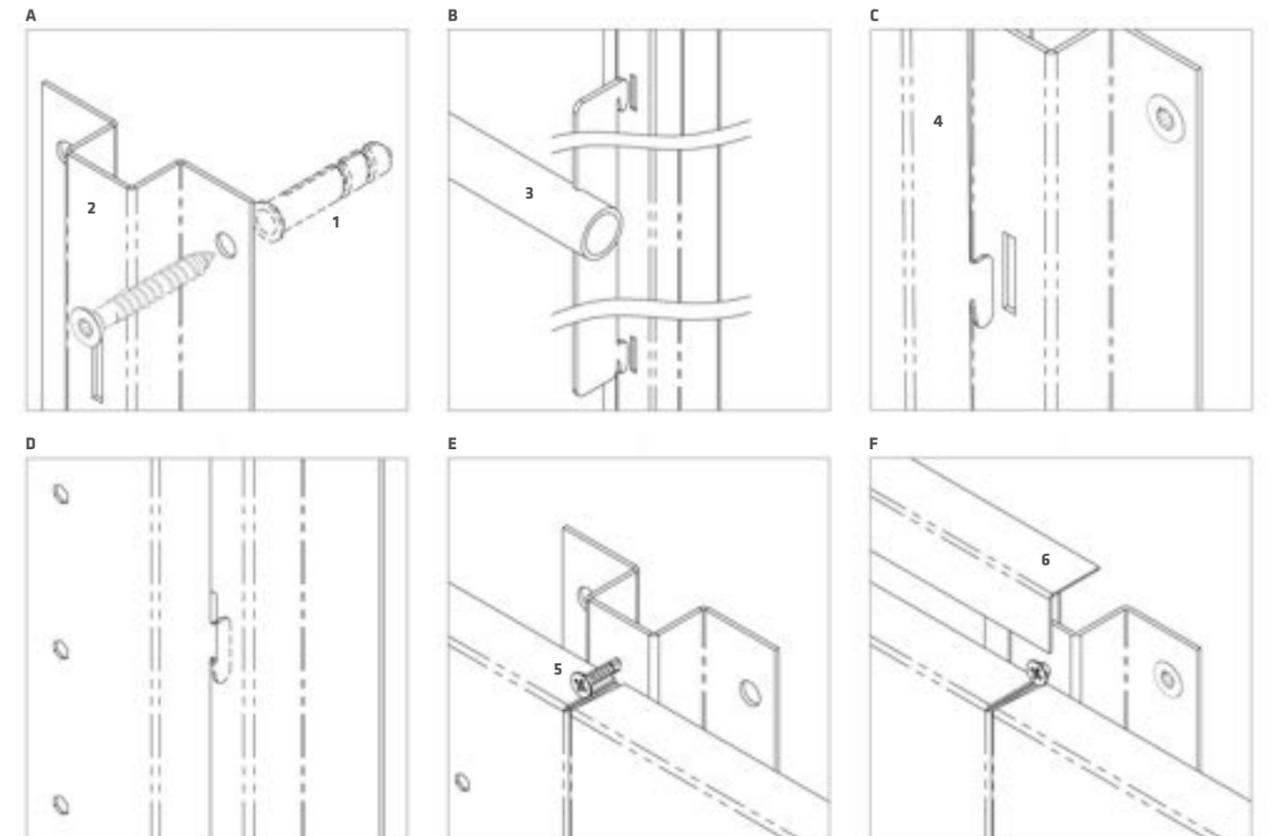
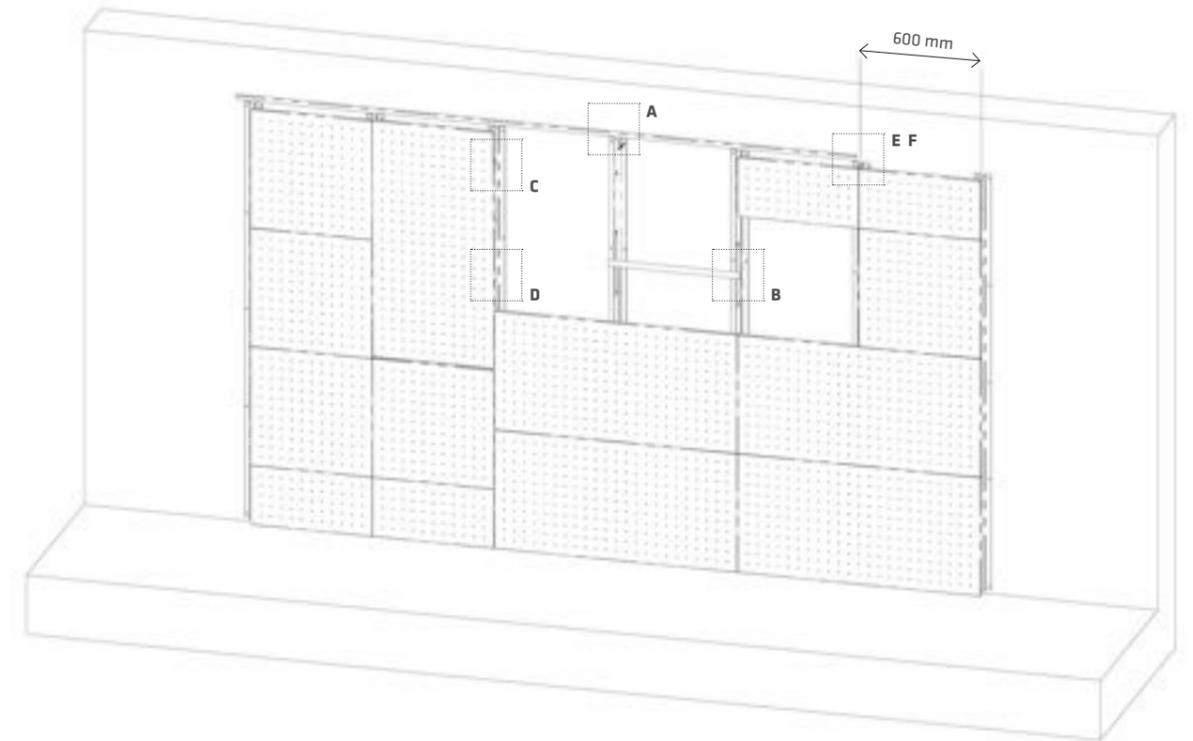

# MOSSwall® Acoustic

PARETE A MURO  
WALL MOUNTING  
PAROI MURALE

1	Montante singolo L120xP11cm	Single upright L120xD11cm	Montant simple L120 x P11 cm
2	Montante doppio L160xP11cm	Double upright L160xD11cm	Montant double L160 x P11 cm
3	Pannelli in lamiera di acciaio zincato rivestito con film in PVC	Galvanised sheet steel panels covered with PVC film	Panneaux en tôle d'acier zingué avec revêtement PVC
4	Fori per fissaggio a parete	Slots for wall fixing	Trous de fixation au mur
5	Sistema ad incastro per accostare i pannelli	Click-fastening system to place panels side-by-side	Système d'emboîtement pour rapprochement des panneaux

Schema generico con pannelli  
600x400mm

General diagram with  
600 x 400 mm panels

Schéma général avec panneaux  
600 x 400 mm

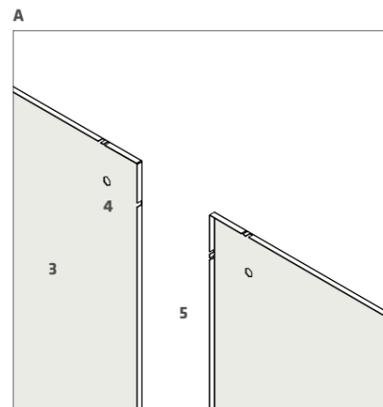
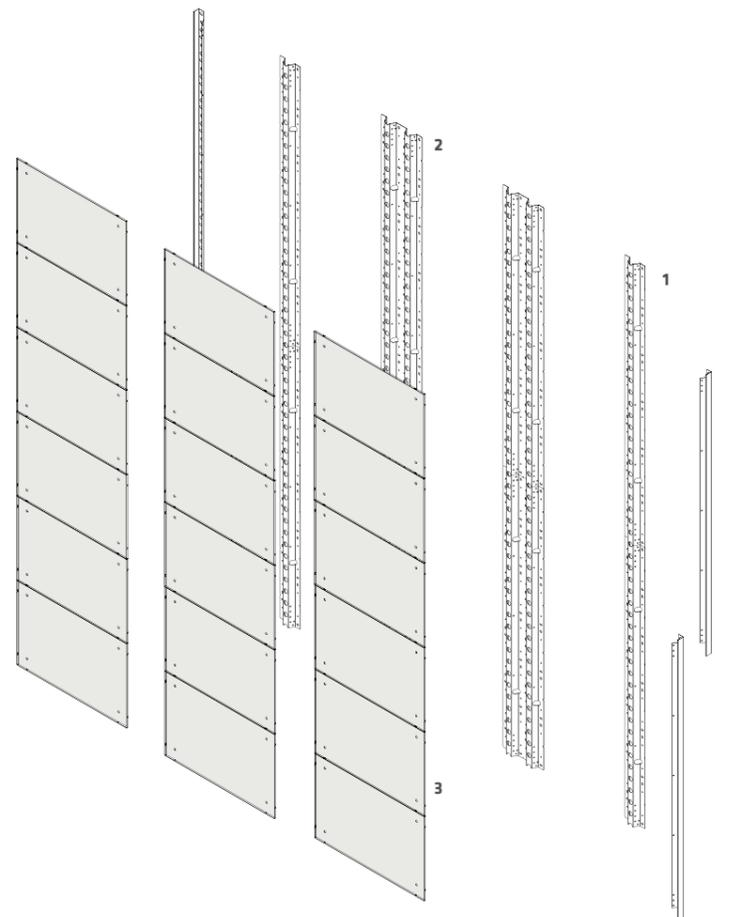
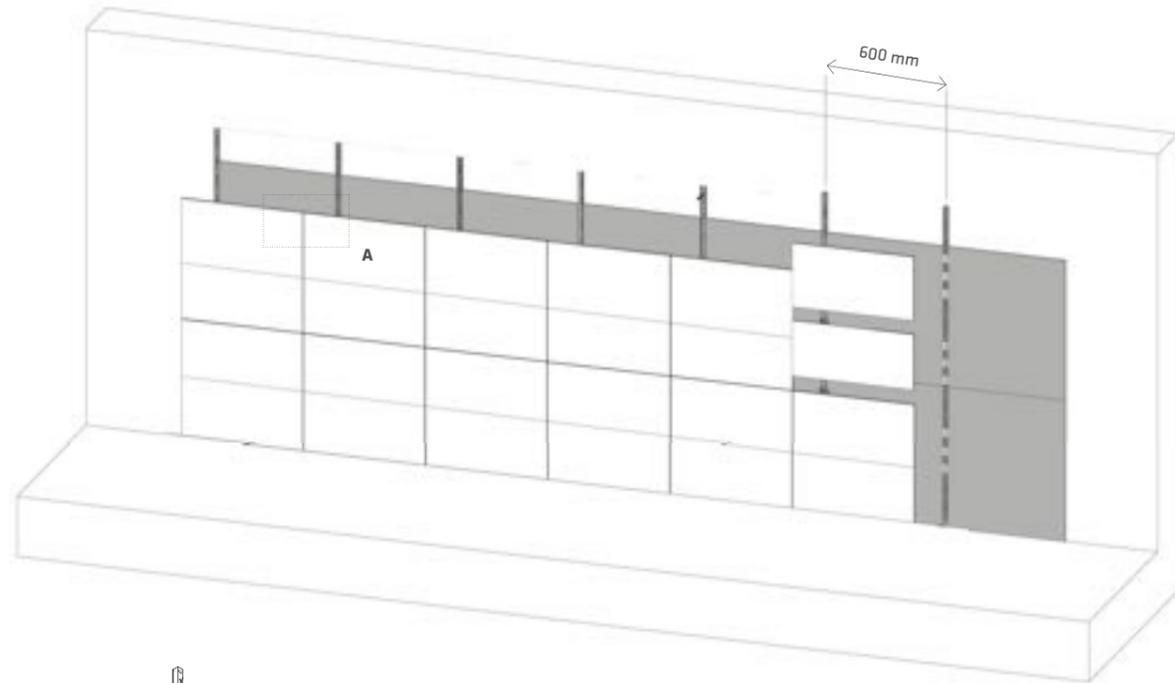

# MOSSwall® Acoustic

PARETE A SPINTA  
ROOM DIVIDER  
PAROI EN POUSSÉE

1	Montante singolo L120xP11cm	Single upright L120xD11cm	Montant simple L120 x P11 cm
2	Montante doppio L160xP11cm	Double upright L160xD11cm	Montant double L160 x P11 cm
3	Pannelli in lamiera di acciaio zincato rivestito con film in PVC	Galvanised sheet steel panels covered with PVC film	Panneaux en tôle d'acier zingué avec revêtement PVC
4	Aggancio a soffitto	Ceiling attachment	Fixation au plafond
5	Carter di chiusura	Closing casing	Coque de clôture
6	Base	Base	Base

Schema esemplificativo di due  
moduli 2400x600mm

Sample diagram of two  
2400 x 600 mm modules

Schéma d'exemple de deux modules  
2400 x 600 mm

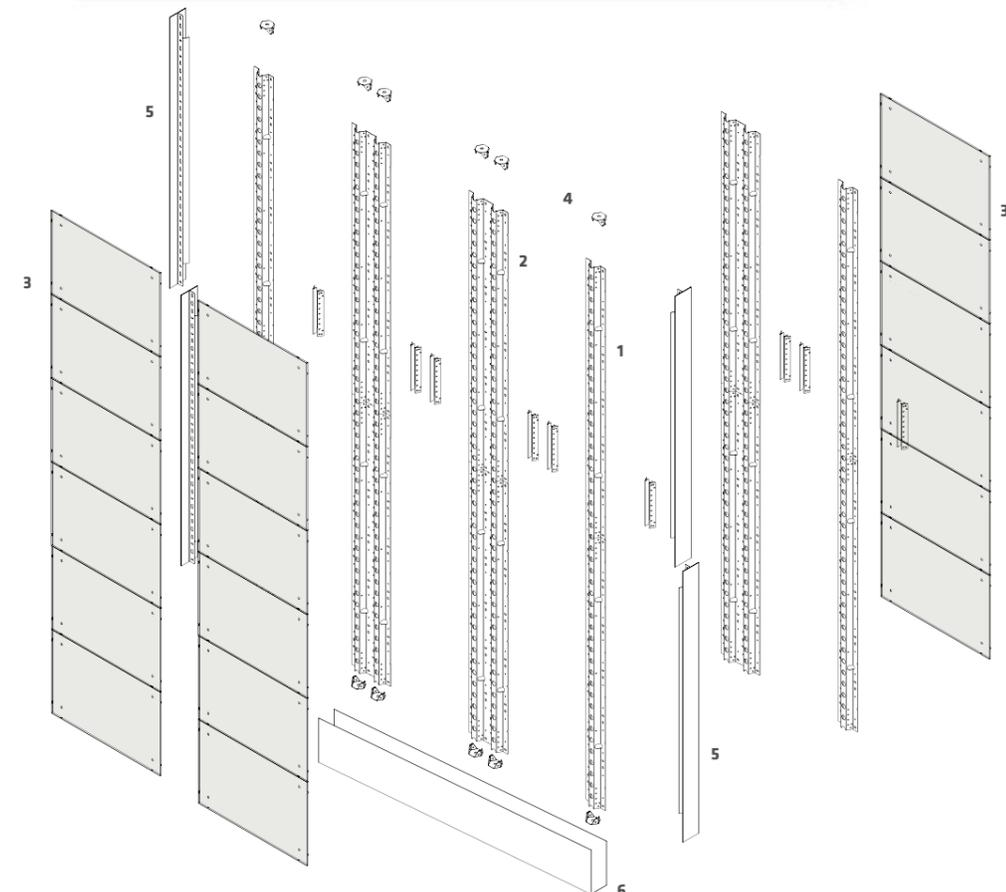
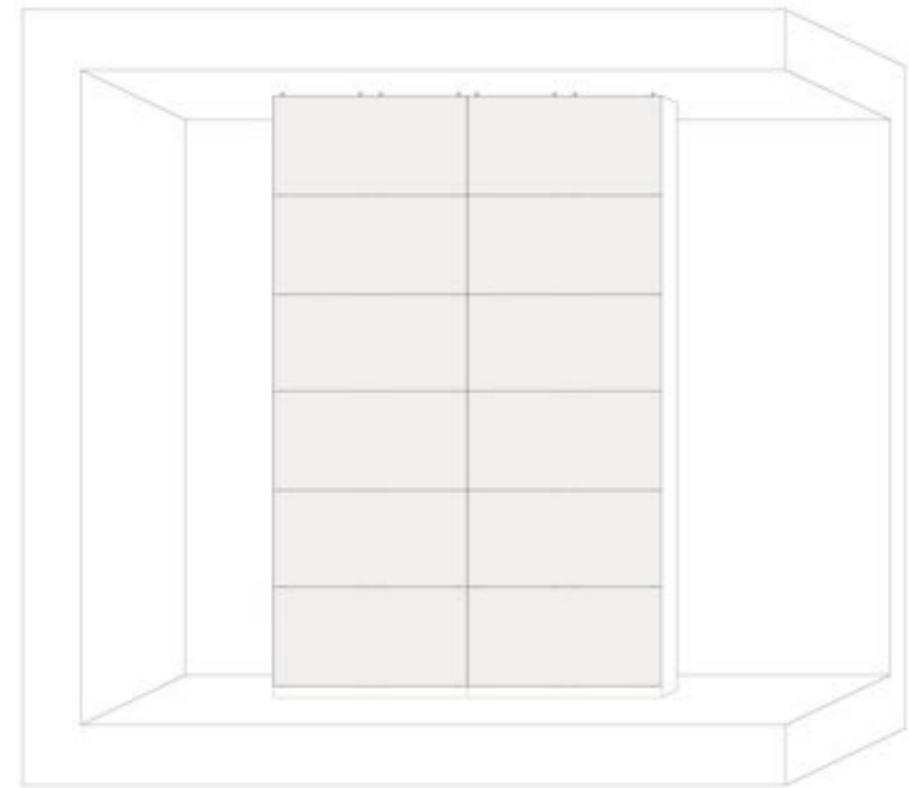



# Fonology

sound architecture

## **FONOLUOGO HEADQUARTER**

via Brenta 7  
36010 Carré (VI) Italy  
t. +39 0445 314931  
info@fonology.it  
[www.fonology.it](http://www.fonology.it)

## **MILANO SHOWROOM**

Via Gian Galeazzo, 31  
20136 Milano (MI) - Italy  
T +39 02 58441556  
milano@aresline.com

## **PARIS SHOWROOM**

4, Rue de Berri  
75008 Paris - France  
T +33 01 47643059  
paris@aresline.com

## **NICARAGUA SHOWROOM**

Av. del Campo  
Las Colinas,  
Managua - Nicaragua

## **MAROC SHOWROOM**

Lotissement Hamaza,  
residence Jnane, Eddalia bureau n°11  
Bouznika - Marocco  
+212 (0) 537649712  
info@contractdesignnetworkmaroc.ma

