

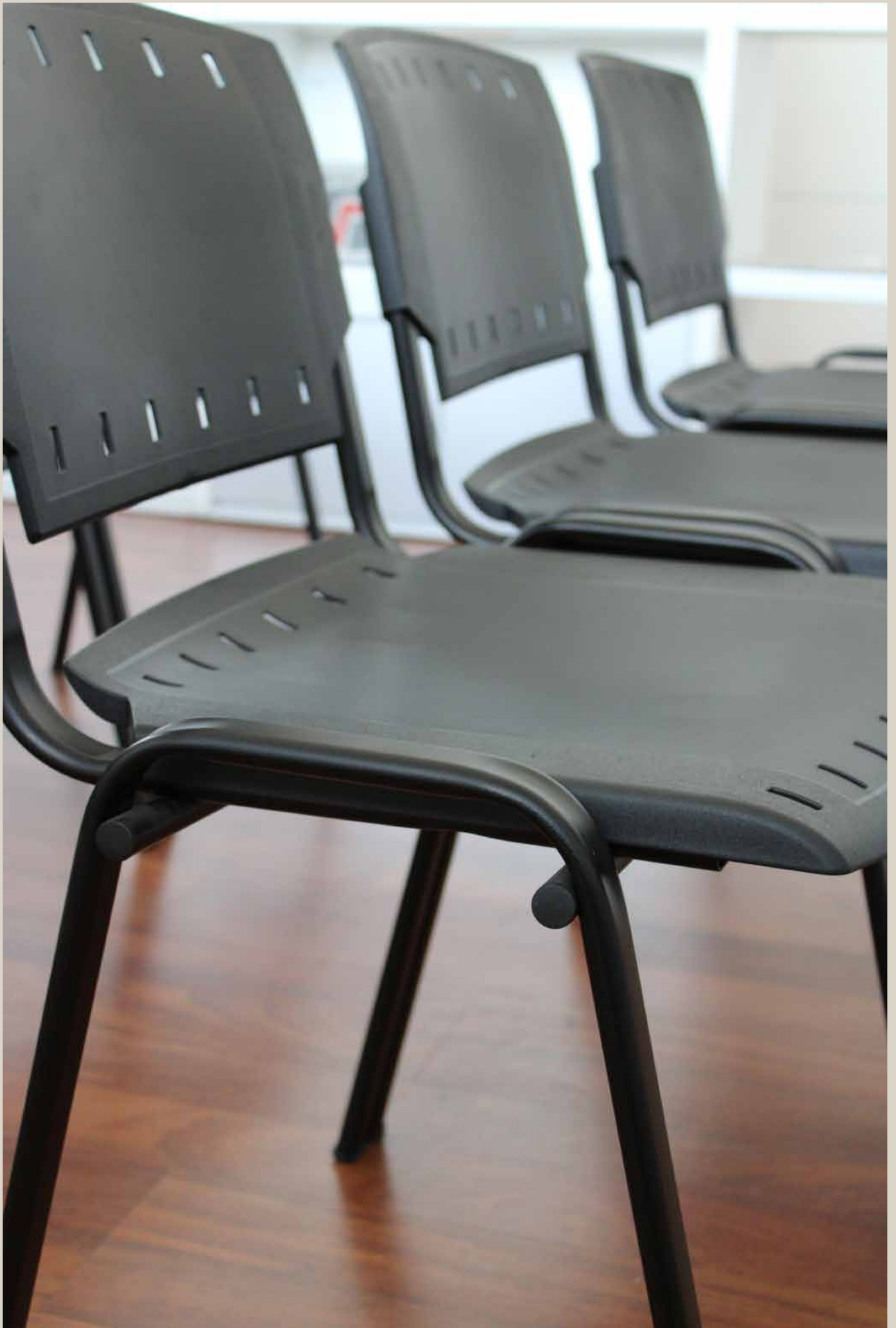

SIIGI





EXCELLENCE MADE IN ITALY



SIGMA

chair is suitable to be used in many different environments such as public spaces, waiting rooms, multipurpose rooms for meetings or events, schools, sporting events; it has a great versatility.

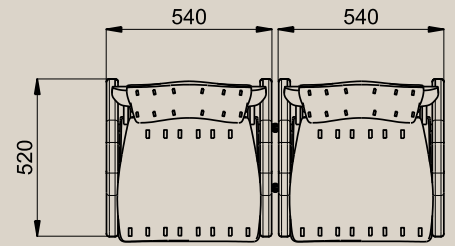
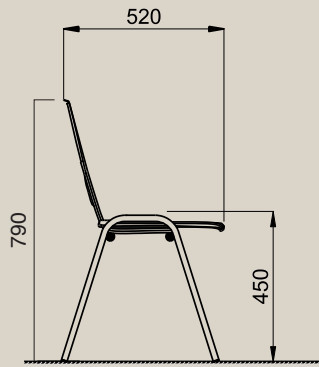

Comfort together with its essential design, make the **Sigma** chair suitable for any situation.

The seat and back are in first choice colored polypropylene, also available Fire retardant and UV protected.

Upon request it can be equipped with upholstered panels with customized padding according to customer's requests.



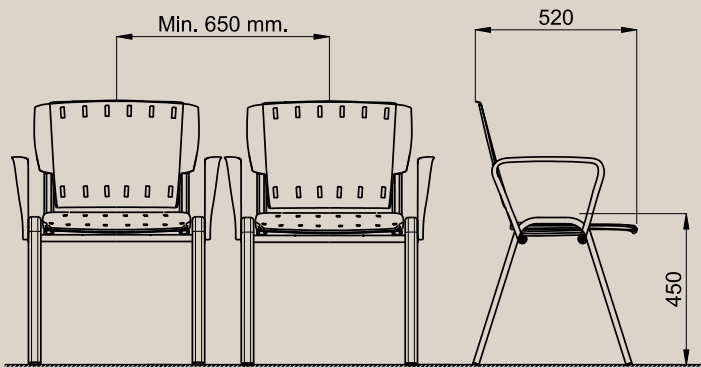

DIMENSIONS:

depth: 520 mm
seat height: 450 mm
total height: 790 mm
width with armrests: 640 mm
width without armrests: 540 mm

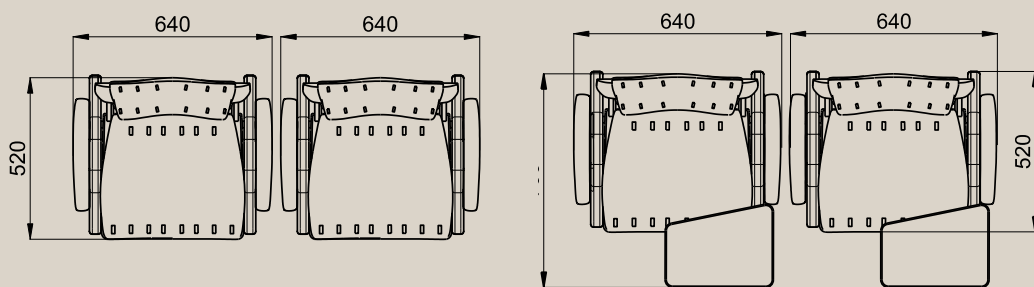

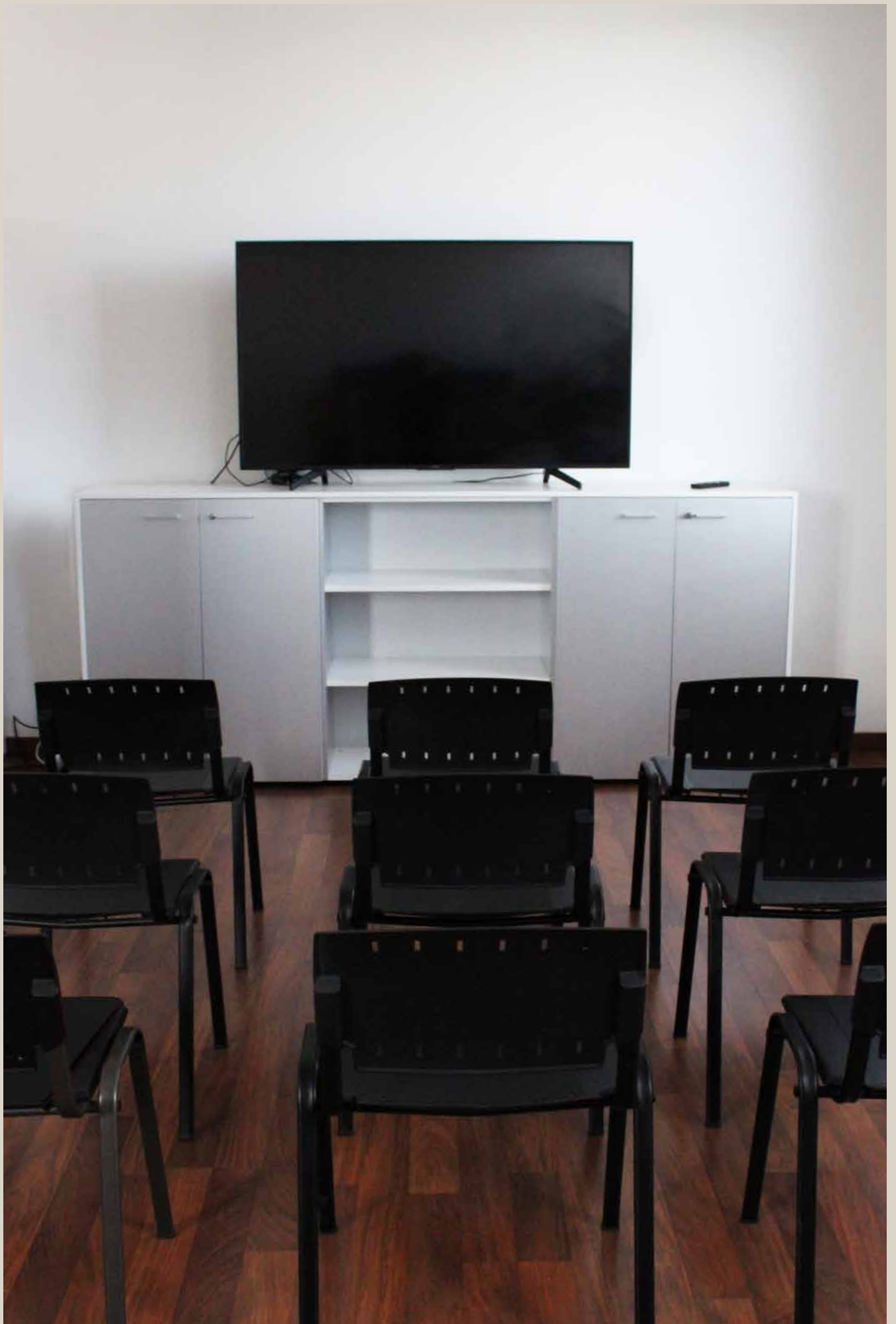



The 4-legged frame is made of 30x15 mm oval tubular; with 18 mm diameter round tubular crosspieces used for fixing the armrests or the arm which holds the writing tablet (both options can be added at a later time if required).

Frame painted with epoxy powders, black color. On request, outdoor treatments are available, such as cataphoresis and outdoor painting.

Standard colors:



BLUE RAL 5002



BLACK RAL 9005





Its several accessories such as the armrest, the tablet, the alignment hook in welded wire, or in gripper or plug-in plastic material, make it one of the most complete seats in its reference field.



Logo and sponsor can be eventually sewed on the back.

Stackability: minimum 15 seats without armrests and 5 seats with armrests or tablet.

An appropriate seat trolley is available to easily move up to 15 seats.



EXCELLENCE MADE IN ITALY

3 DIFFERENT HOOKS TYPES:

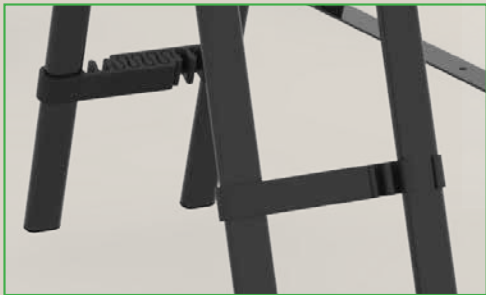

1



2



3

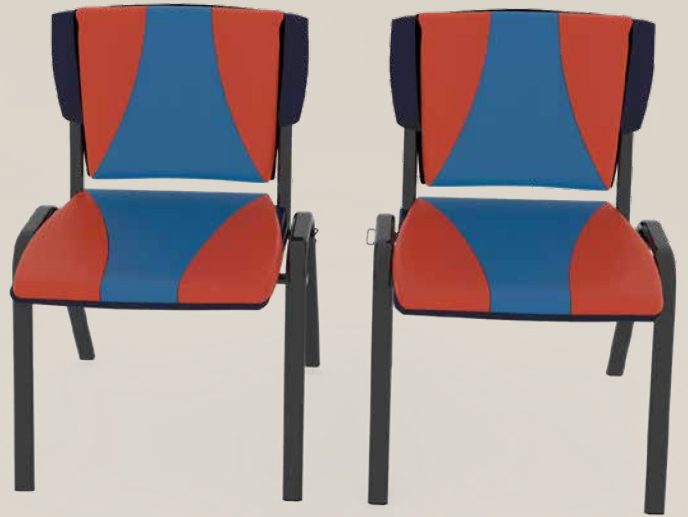

ROWS SPACE BAR



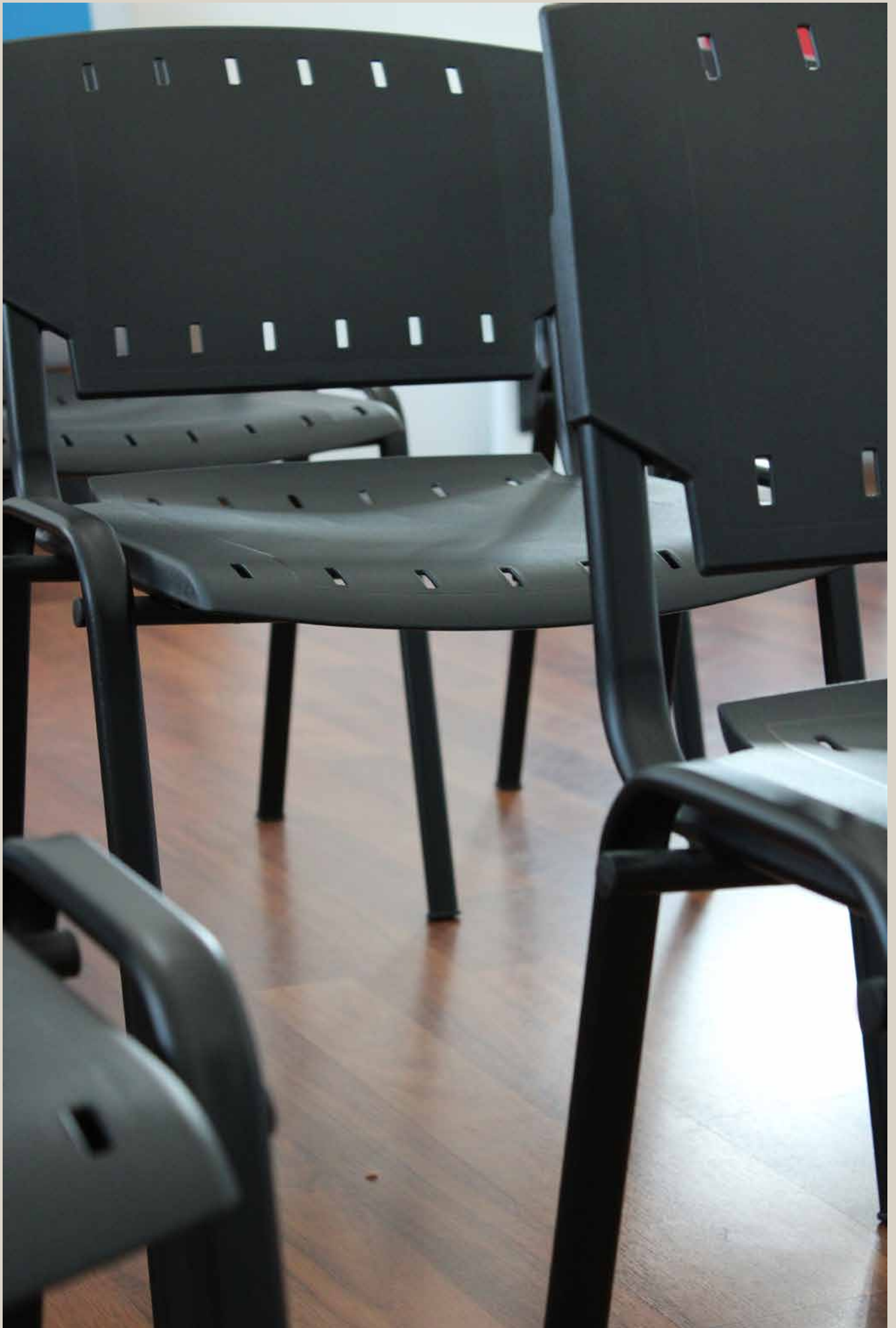

SIGMA

Tested to comply with UNI EN 1729:2012
(Test for determination of strength and durability).



Static load test

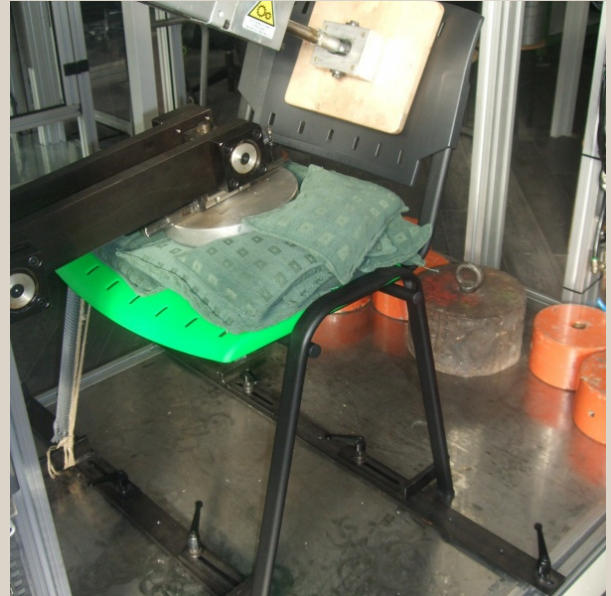

Static load test 1st level

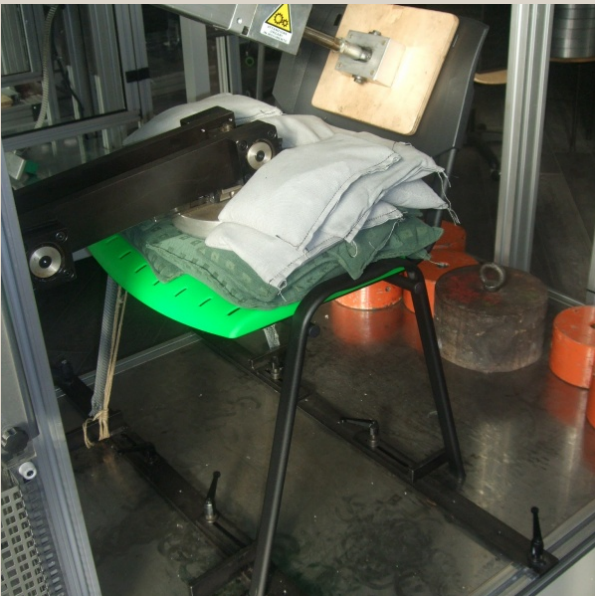

Static load test 2nd level

EXCELLENCE MADE IN ITALY



Via Parini, 3 - 40069 Zola Predosa (BO) Italy
Tel. +39 051 6164311 - Fax +39 051 6164317 - info@omsi.it - www.omsi.it